

# Holzknöpfe

B = Buche; F = Fichte



6091/35 B  
6091/35 F



6090/30 B  
6090/30 F



6089/25 B  
6089/25 F



6088/21 B  
6088/21 F



6202  
Buche



6203  
Buche



6201  
Buche



6200  
Buche

H

## Holzknöpfe in weiteren Holzarten:

B = Buche Bi = Birke E = Eiche F = Fichte K = Kirsch N = Nuß M = Mahagoni



6022/B /E /F /K /N



6024/B /E /F /K /N



6209/Bi /E /K /N /M

## Holzknöpfe



**6206**  
Buche



**6207**  
Buche



**6205**  
Buche



**6208**  
Buche



**6780/12**  
Buche



**6780/15**  
Buche



**6097**  
Buche



**6098**  
Buche



**6204**  
Buche

H

## Holzfüße

B = Buche; E = Eiche; F = Fichte; Kf = Kiefer; K = Kirsch; N = Nuß



**6011/B /Kf**  
Ø 50 mm  
Höhe: 45 mm



**6234** Erle  
Ø 60 mm  
Höhe: 70 mm



**6235/B**  
**6235/F**  
Ø 65 mm  
Höhe: 70 mm



**6005/B /E /F /K /N**  
Ø 75 mm  
Höhe: 70 mm

# Holzfüße

B = Buche; E = Eiche; F = Fichte; K = Kirsch; N = Nuß



**6083/F**  
Ø 70 mm  
Höhe: 78 mm



**6083/65**  
Fichte  
Ø 65 mm  
Höhe: 60 mm



**6236 Erle**  
Ø 80 mm  
Höhe: 60 mm



**6020/60 B**  
**6020/60 F**  
Ø 60 mm  
Höhe: 75 mm



**6237/B /E /F /K /N**  
Ø 90 mm  
Höhe: 75 mm



**6020/85 B**  
**6020/85 F**  
Ø 85 mm  
Höhe: 90 mm



**6043/F**  
Ø 86 mm  
Höhe: 87 mm



**6082/F**  
Ø 85 mm  
Höhe: 87 mm



**6010/95 F**  
Ø 85 mm  
Höhe: 95 mm



**6003/B /E /F /K /N**  
Ø 90 mm  
Höhe: 80 mm

H

# Holzfüße

B = Buche; E = Eiche; F = Fichte; K = Kirsch; N = Nuß



**6020/75 B**  
**6020/75 F**  
Ø 75 mm  
Höhe: 80 mm



**6010/120 F**  
Ø 65 mm  
Höhe: 120 mm



**6010/130 F**  
Ø 85 mm  
Höhe: 130 mm



**6239 Erle**  
Ø 100 mm  
Höhe: 70 mm



**6238/B /E /F /K /N**  
Ø 90 mm  
Höhe: 80 mm



**6242**  
Buche  
Ø 100 mm  
Höhe: 80 mm



**6045/F**  
Ø 110 mm  
Höhe: 90 mm



**6240/B**  
**6240/F**  
Ø 110 mm  
Höhe: 83 mm

H

## Holzfüße

B = Buche; E = Eiche; F = Fichte; K = Kirsch; N = Nuß



6246/B /F Ø 115 mm, Höhe 50 mm

6247/F Ø 140 mm, Höhe 65 mm

6249/B /F Ø 180 mm, Höhe 58 mm

Höhe: 58 mm



6250/B /F

Ø 120 mm

Höhe: 60 mm



6002/B /E /F /K /N

Ø 150 mm

Höhe: 70 mm



6004/B /E /F /K /N

Ø 100 mm

Höhe: 55 mm



6243 Erle

Ø 120 mm

Höhe: 90 mm



6001/B /E /F /K /N

Ø 120 mm

Höhe: 94 mm

H

## Holzfüße

B = Buche; F = Fichte

**6007/120 B**  
**6007/120 F**  
Ø 120 mm  
Höhe: 75 mm



**6007/100 B**  
**6007/100 F**  
Ø 100 mm  
Höhe: 75 mm

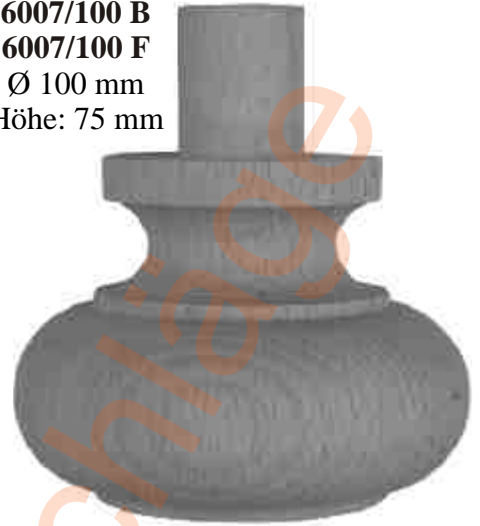

**6007/135 B**  
**6007/135 F**  
Ø 135 mm  
Höhe: 75 mm



**6511/110**

Linde geschnitzt  
Höhe: 110 mm  
Breite: 102 mm



**6511/64**

Linde geschnitzt  
Höhe: 65 mm  
Breite: 79 mm



**6513**

Linde geschnitzt  
Höhe: 85 mm  
Breite: 77 mm



# Holzfüße

Er = Erle; Kf = Kiefer



6245/Er  
6245/Kf  
Ø 170 mm  
Höhe: 120 mm



6244/Er  
6244/Kf  
Ø 135 mm  
Höhe: 100 mm



6918/70 Er  
6918/70 Kf  
Ø 70 mm  
Höhe: 80 mm



6918/90 Er  
6918/90 Kf  
Ø 90 mm  
Höhe: 90 mm



6919/Er  
6919/Kf  
Ø 95 mm  
Höhe: 115 mm



6000/120 Er  
6000/120 Kf  
6000/140 Er  
6000/140 Kf  
Höhe 120 mm  
bzw. 140 mm



6917/Er  
6917/Kf  
Ø 100 mm  
Höhe: 100 mm



6042/80 Er  
6042/80 Kf  
6042/105 Er  
6042/105 Kf  
Höhe 80 mm  
bzw. 105mm



6044/80 Er  
6044/80 Kf  
6044/105 Er  
6044/105 Kf  
Höhe 80 mm  
bzw. 105mm

H

# Holzfüße

A = Ahorn; Er = Erle; F = Fichte; Kf = Kiefer

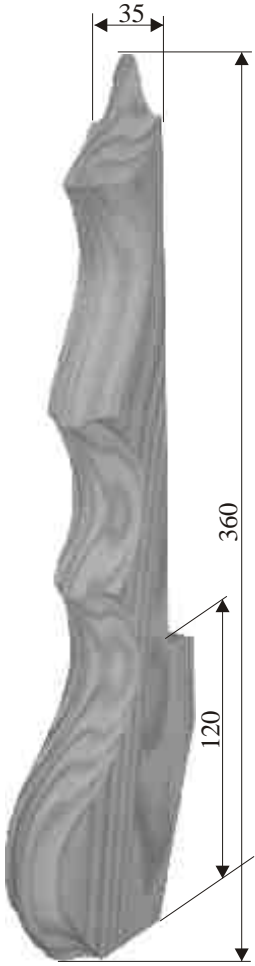

6069/355 A  
6069/355 F

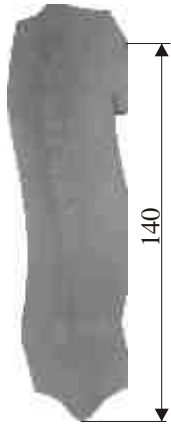

6213/Er  
6213/Kf  
140x35 mm

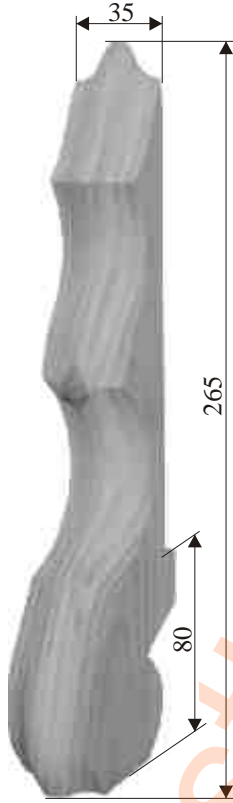

6069/260 A  
6069/260 F

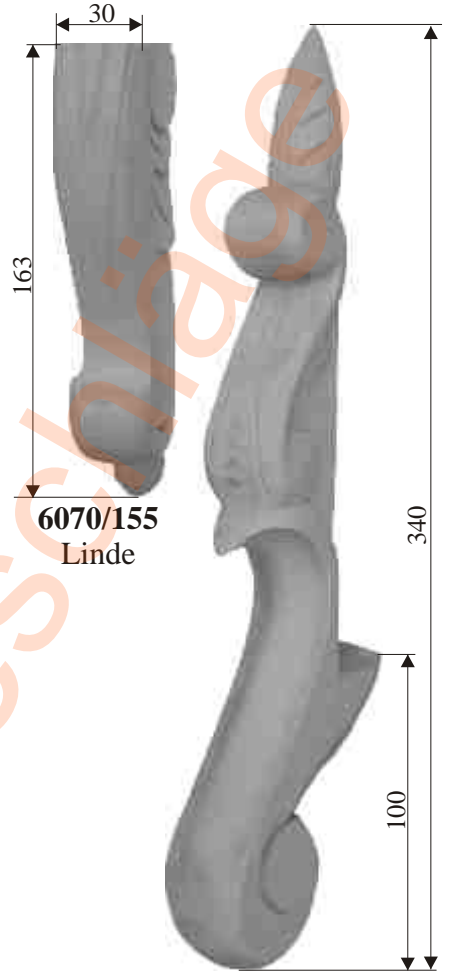

6070/155  
Linde

6070/340 Linde  
Breite: 35 mm

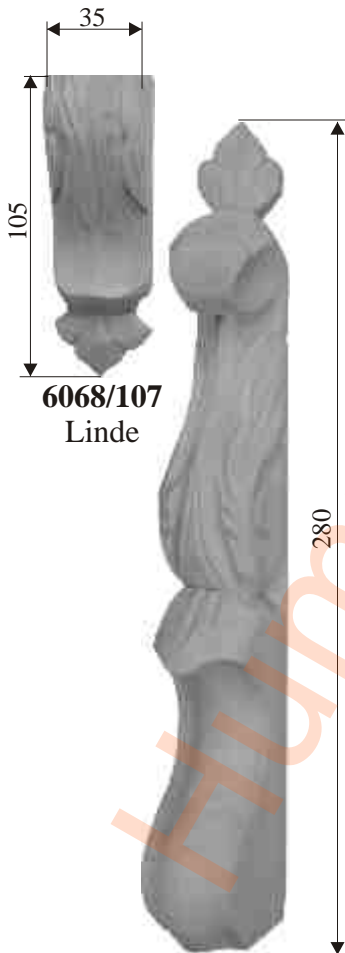

6068/107  
Linde

6068/280 Linde  
Breite: 35 mm



6072/340 Linde  
Breite: 35 mm

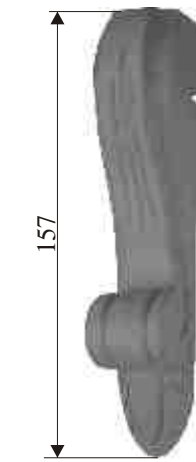

6241/160  
Linde  
Breite: 30 mm



6241/350 Linde  
Breite: 40 mm

H



# Holzsäulen

B = Buche; Bi = Birke; E = Eiche; F = Fichte; Li = Linde

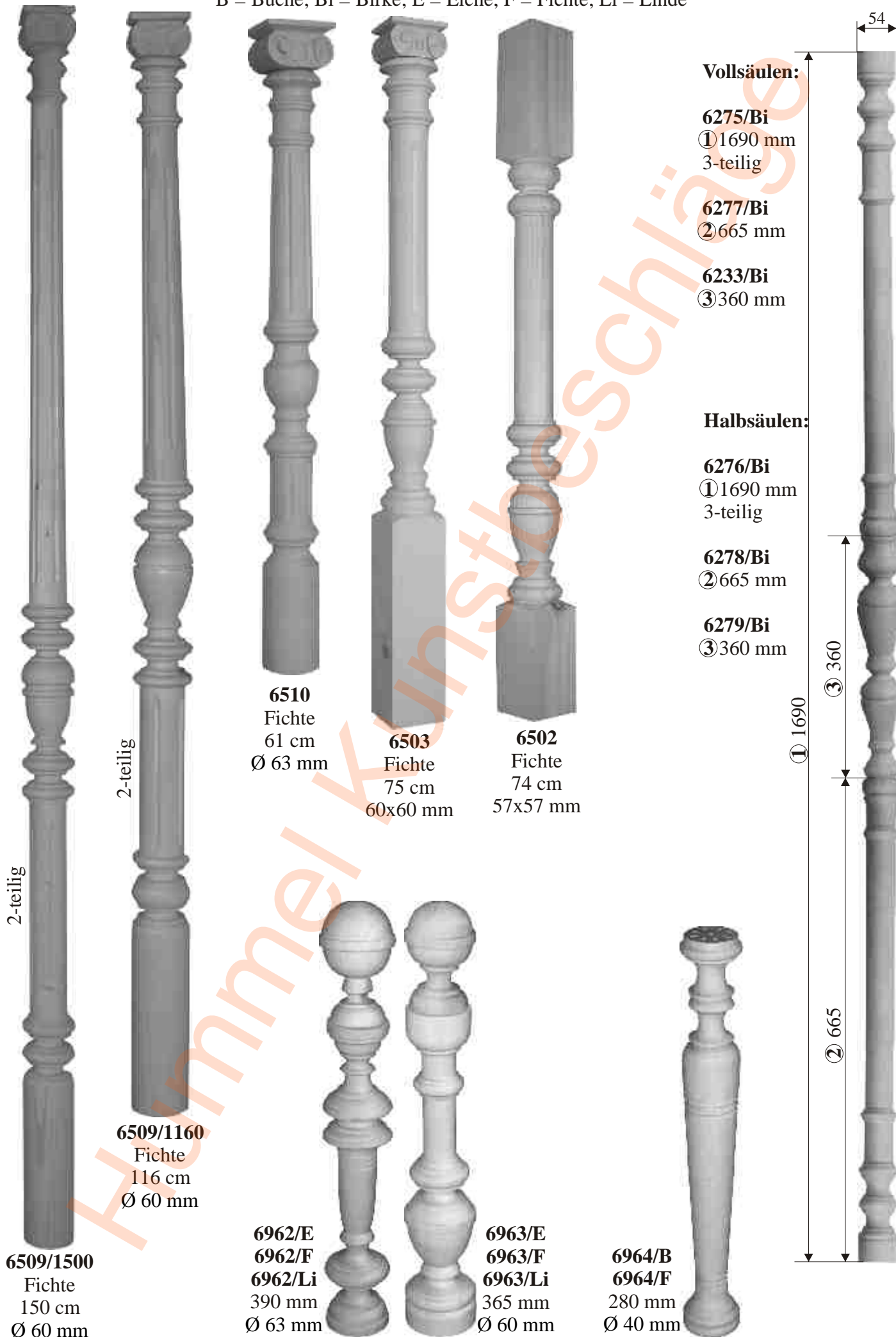

**Vollsäulen:**

- 6275/Bi**  
① 1690 mm  
3-teilig
- 6277/Bi**  
② 665 mm
- 6233/Bi**  
③ 360 mm

**Halbsäulen:**

- 6276/Bi**  
① 1690 mm  
3-teilig
- 6278/Bi**  
② 665 mm
- 6279/Bi**  
③ 360 mm

2-teilig

2-teilig

**6510**  
Fichte  
61 cm  
Ø 63 mm

**6503**  
Fichte  
75 cm  
60x60 mm

**6502**  
Fichte  
74 cm  
57x57 mm

**6509/1160**  
Fichte  
116 cm  
Ø 60 mm

**6509/1500**  
Fichte  
150 cm  
Ø 60 mm

**6962/E**  
**6962/F**  
**6962/Li**  
390 mm  
Ø 63 mm

**6963/E**  
**6963/F**  
**6963/Li**  
365 mm  
Ø 60 mm

**6964/B**  
**6964/F**  
280 mm  
Ø 40 mm



# Holzdrehteile

Bi = Birke; E = Eiche; F = Fichte ; Kf = Kiefer



**6230/Bi /Kf**  
Ø 65 mm  
Höhe: 240 mm



**6231/Bi /E /F**  
Ø 90 mm  
Höhe: 270 mm



**6593/Bi**  
Ø 65 mm  
Höhe: 290 mm



**6233/Bi /Kf**  
Ø 65 mm  
Höhe: 360 mm



halb: **6086/Bi**  
voll: **6087/Bi**  
Ø 33 mm  
Höhe: 290 mm



**6582/Bi**  
Ecksäule  
Länge 260 mm  
Ø 43 mm

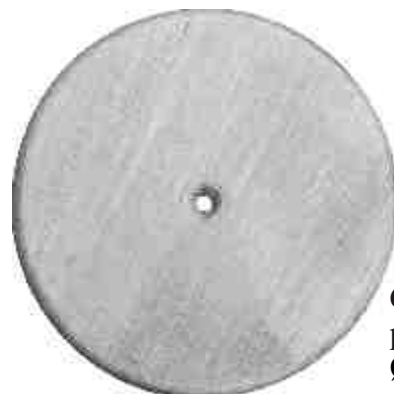

**6583/Bi**  
passend zu 6582/Bi  
Ø 52 mm

## Holzteile

Er = Erle; Kf = Kiefer



**6099/70 Er**  
**6099/70 Kf**  
Ø 70 mm



**6099/40 Er**  
**6099/40 Kf**  
Ø 40 mm



**6225/Bi /E /M /N**  
Bi = Birke  
E = Eiche  
M = Mahagoni  
N = Nuß



**6015**  
Fichte  
Höhe: 282 mm  
Breite: 130 mm  
1 Paar  
(rechts und links)

**6099/100 Er**  
**6099/100 Kf**  
Ø 100 mm  
o. Abb:  
**6099/140 Er**  
**6099/140 Kf**  
Ø 140 mm

**6067**  
Linde  
Höhe: 290 mm  
Breite: 135 mm  
1 Paar  
(rechts und links)

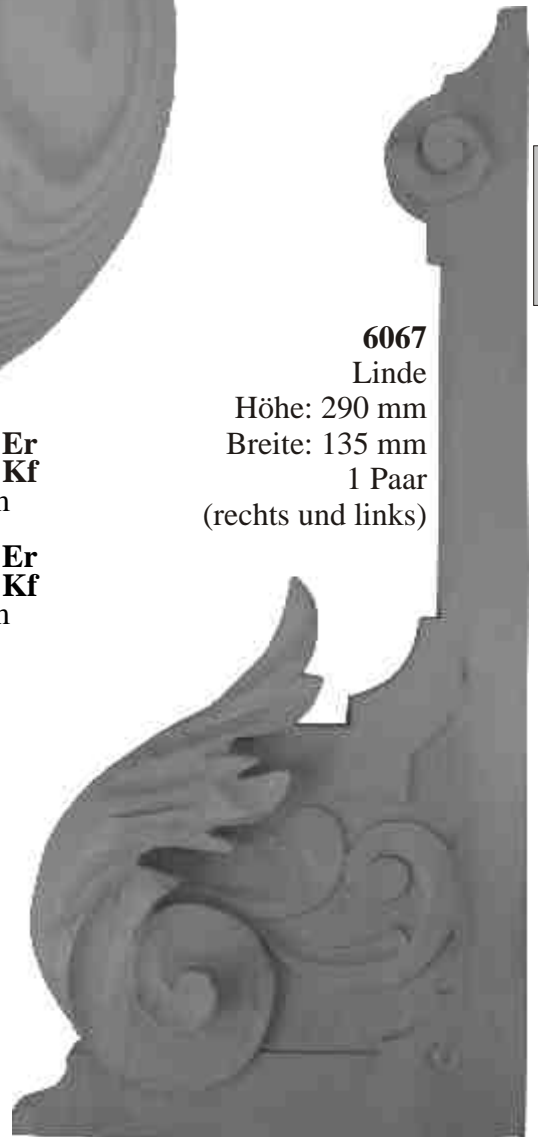

H

# Holzdrehteile

B = Buche; F = Fichte



6037/B  
6037/F



6574  
Buche



6016/F

H



6219  
Buche



6040  
Buche



6577  
Buche

# Holzdrehteile

B = Buche; F = Fichte



6017/B



6078/F

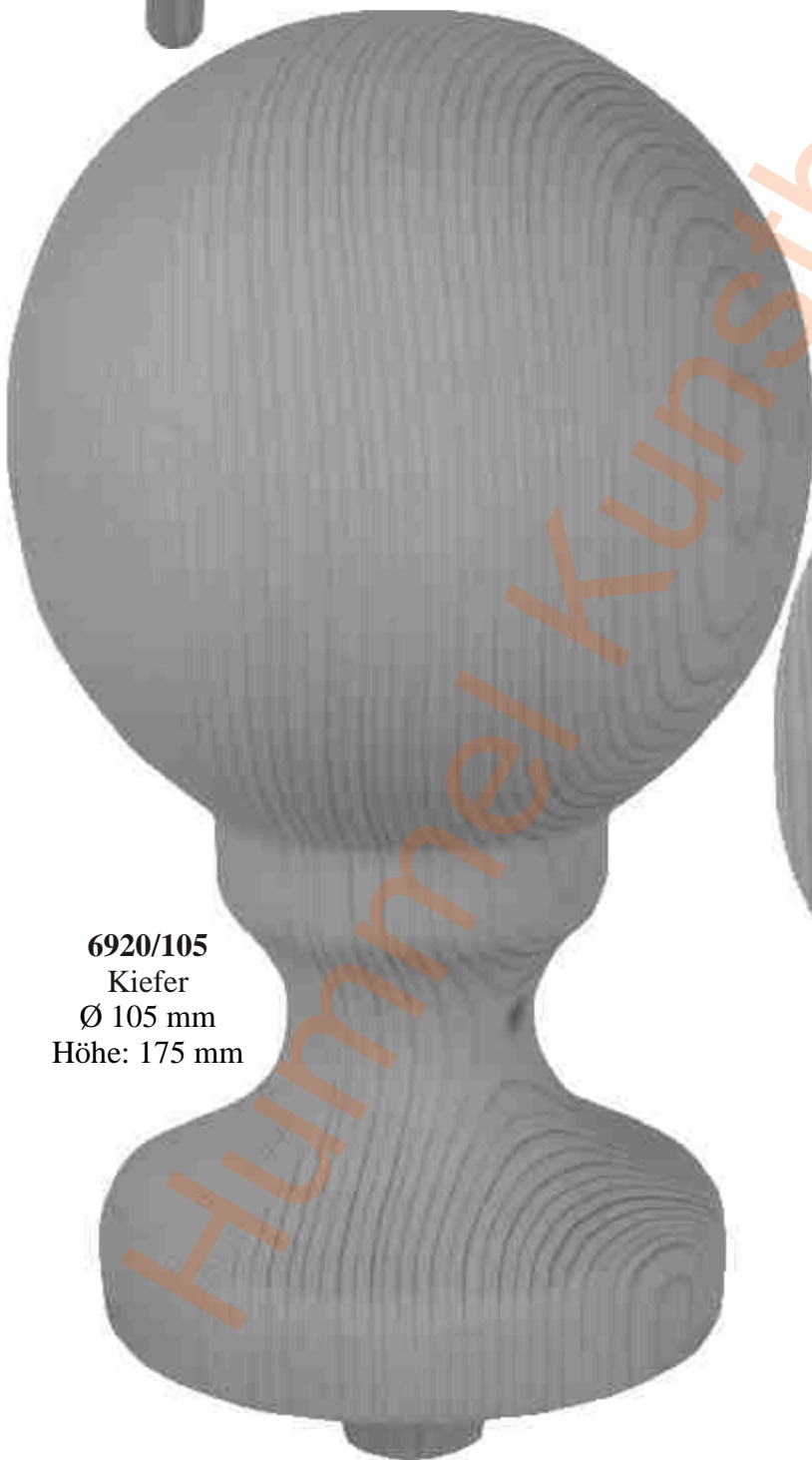

6920/105  
Kiefer  
Ø 105 mm  
Höhe: 175 mm

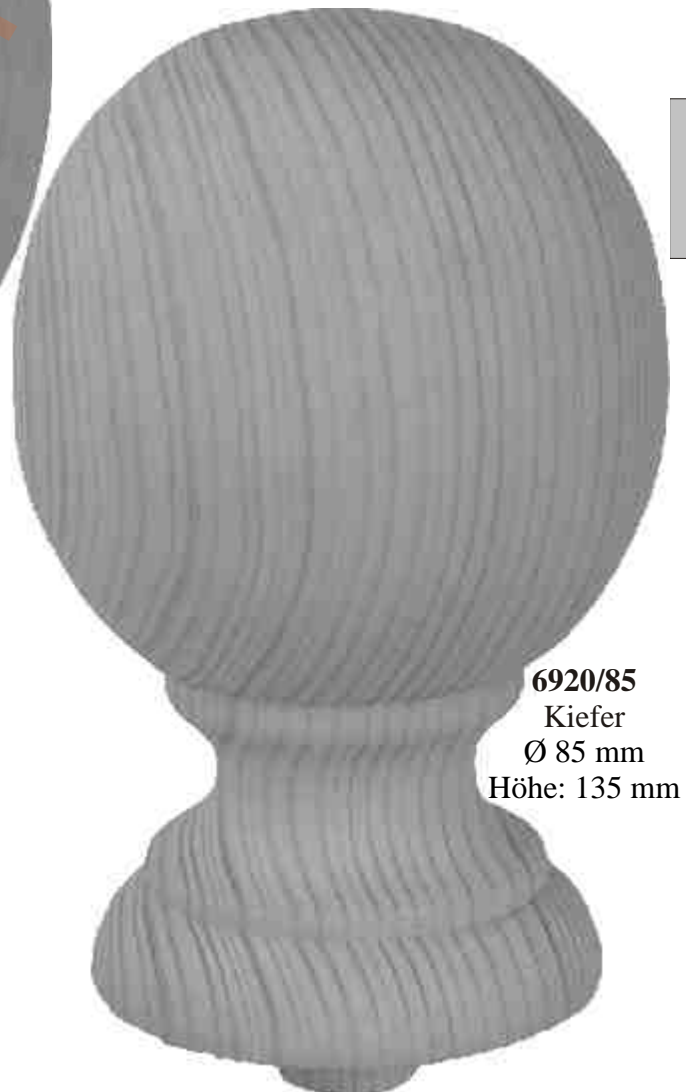

6920/85  
Kiefer  
Ø 85 mm  
Höhe: 135 mm

H

# Holzdrehteile in Buche



6575



6218



6220

H



6039



6573/50  
6573/60  
6573/70



6038

# Holzdrehteile in Buche

## Holzsäulen und Knöpfchen für Galerien



6052



6074



6049



6075



6548/F Fichte  
6548/B Buche



6051  
Erle



6050



6054



6055



6053



6079



6221

H

# Holzzierteile (B = Buche; Er = Erle; F = Fichte)



**6226/R**  
Buche



**6226/S**  
Buche



**6226/15 B**  
**6226/15 F**



<b>Erle:</b>	<b>Fichte:</b>
6035/70x50 Er	6035/70x50 F
6035/90x40 Er	6035/90x40 F
6035/90x55 Er	6035/90x55 F
6035/50x100 Er	6035/50x100 F
6035/75x80 Er	6035/75x80 F
6035/170x50 Er	6035/170x50 F
6035/170x70 Er	6035/170x70 F
6035/32x17 Er	6035/32x17 F
6035/35x30 Er	6035/35x30 F



**6226 B**  
**6226 F**



**6227 B**  
**6227 F**



**6226/25 B**  
**6226/25 F**



**6226/29 B**  
**6226/29 F**



**6226/30 B**  
**6226/30 F**

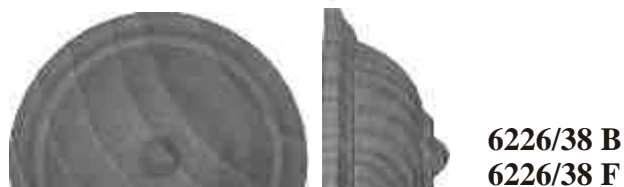

**6226/38 B**  
**6226/38 F**



**6226/39 B**  
**6226/39 F**



**6226/45 B**  
**6226/45 F**



<b>Buche: (ØxBreite)</b>	<b>Fichte: (ØxBreite)</b>
<b>6599/35 B</b> (35x35 mm)	<b>6599/35 F</b> (35x35 mm)
<b>6599/40 B</b> (40x40 mm)	<b>6599/40 F</b> (40x40 mm)
<b>6599/45 B</b> (40x45 mm)	<b>6599/45 F</b> (40x45 mm)
<b>6599/50 B</b> (40x50 mm)	<b>6599/50 F</b> (40x50 mm)
<b>6599/55 B</b> (40x55 mm)	<b>6599/55 F</b> (40x55 mm)
<b>6599/60 B</b> (45x60 mm)	<b>6599/60 F</b> (45x60 mm)
<b>6599/65 B</b> (45x65 mm)	<b>6599/65 F</b> (45x65 mm)
<b>6599/70 B</b> (53x70 mm)	<b>6599/70 F</b> (53x70 mm)
<b>6599/75 B</b> (55x75 mm)	<b>6599/75 F</b> (55x75 mm)
<b>6599/80 B</b> (55x80 mm)	<b>6599/80 F</b> (55x80 mm)

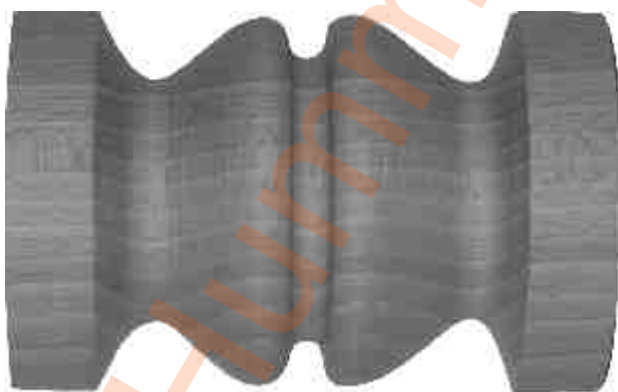

<b>Buche: (ØxBreite)</b>	<b>Fichte: (ØxBreite)</b>
<b>6598/40 B</b> (40x40 mm)	<b>6598/40 F</b> (40x40 mm)
<b>6598/50 B</b> (40x50 mm)	<b>6598/50 F</b> (40x50 mm)
<b>6598/60 B</b> (45x60 mm)	<b>6598/60 F</b> (45x60 mm)
<b>6598/70 B</b> (50x70 mm)	<b>6598/70 F</b> (50x70 mm)
<b>6598/80 B</b> (53x80 mm)	<b>6598/80 F</b> (53x80 mm)

H



# Holzapplikationen

B = Buche; F = Fichte; Kf = Kiefer; Li = Linde



6591/50 B 6591/50 F  
 6591/55 B 6591/55 F  
 6591/60 B 6591/60 F  
 6591/65 B 6591/65 F  
 Höhe: 115 mm



6571 Linde  
 110x55 mm



6572 Linde  
 110x59 mm



6594/Kf  
 6594/Li  
 85x65 mm



6542/35  
 6542/40  
 6542/45  
 6542/50  
 Linde  
 Höhe: 120 mm



6544/35  
 6544/40  
 6544/45  
 6544/50  
 Linde  
 Höhe: 120 mm



6047/35  
 6047/40  
 6047/45  
 6047/50  
 Linde  
 Höhe: 115 mm



6546/35  
 6546/40  
 6546/45  
 6546/50  
 6546/55  
 Linde  
 Höhe: 120 mm

H



6789 Linde  
 145x70 mm



6048 Linde  
 165x57 mm



6569 Linde  
 157x55 mm



6547/35  
 6547/40  
 6547/45  
 6547/50  
 Linde  
 Höhe: 120 mm

## Holzapplikationen

Bi = Birke; Er = Erle; Kf = Kiefer



**6570 Linde**  
130x58 mm



**6580/Bi**  
**6580/Kf**  
118x55 mm



**6025 Buche**  
Pressholz  
113x50 mm

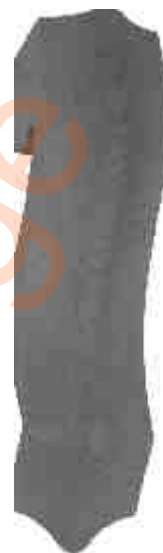

**6213/Er /Kf**  
140x35 mm



**6576 Bi**  
**6576 Kf**  
150x50 mm



**6921/130 Linde**  
130x94x94 mm



**6921/90 Linde**  
90x65x65 mm



**6026/125 Linde**  
125x50 mm



**6026/140 Linde**  
142x60 mm



**6568 Fichte**  
190x90 mm

# Holzapplikationen

Bi = Birke; B = Buche; F = Fichte; Kf = Kiefer



### Buche:

- 6008/35 B** (35x120 mm)
- 6008/40 B** (40x115 mm)
- 6008/45 B** (45x115 mm)
- 6008/50 B** (50x125 mm)
- 6008/55 B** (55x125 mm)
- 6008/60 B** (60x140 mm)
- 6008/65 B** (65x140 mm)
- 6008/70 B** (70x160 mm)
- 6008/75 B** (75x160 mm)
- 6008/80 B** (80x170 mm)

### Fichte:

- 6008/35 F** (35x120 mm)
- 6008/40 F** (40x115 mm)
- 6008/45 F** (45x115 mm)
- 6008/50 F** (50x125 mm)
- 6008/55 F** (55x125 mm)
- 6008/60 F** (60x140 mm)
- 6008/65 F** (65x140 mm)
- 6008/70 F** (70x160 mm)
- 6008/75 F** (75x160 mm)
- 6008/80 F** (80x170 mm)



**6211/Bi**  
**6211/Kf**  
110x45 mm



**6212/Bi**  
**6212/Kf**  
145x60 mm



**6033/B**  
Oblt.: 85x77 mm  
Untl.: 60x90 mm  
Buche



**6578/55 Bi**  
**6578/55 Kf**  
75x55 mm



**6578/75 Bi**  
**6578/75 Kf**  
75x75 mm



**6579/55 Bi**  
**6579/55 Kf**  
100x55 mm



**6579/75 Bi**  
**6579/75 Kf**  
120x75 mm

H

# Holzapplikationen

B = Buche; F = Fichte; Li = Linde



**6056/F**  
170x42 mm



**6012/F**  
122x38 mm



**6059 Linde**  
156x36 mm



**6058/F**  
**6058/Li**  
184x40 mm



**6013/F**  
238x50 mm



**6057/F**  
170x41 mm

H

Holzapplikationen in Linde geschnitzt

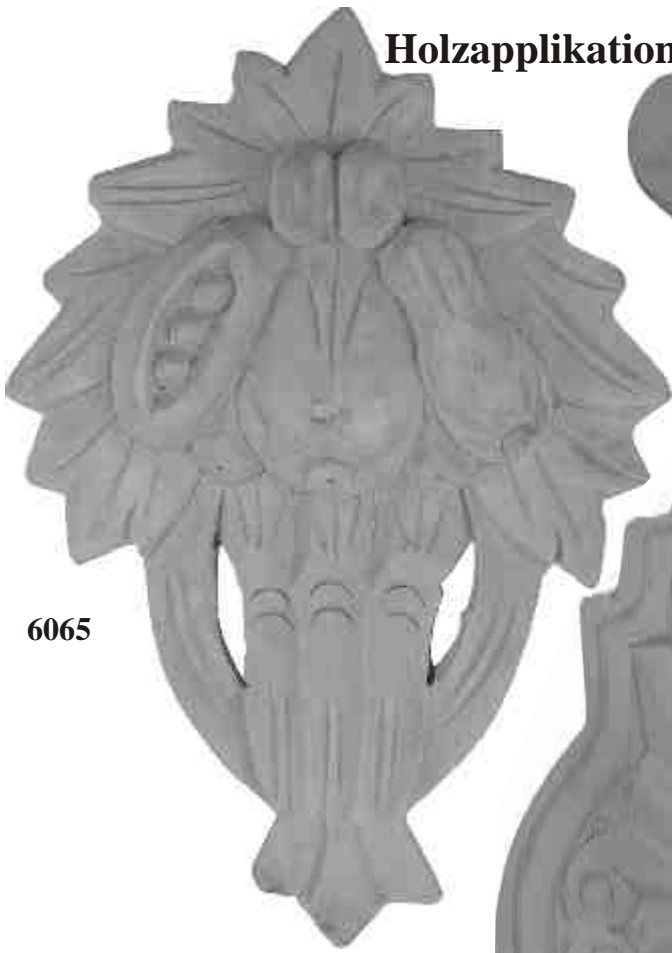

6065

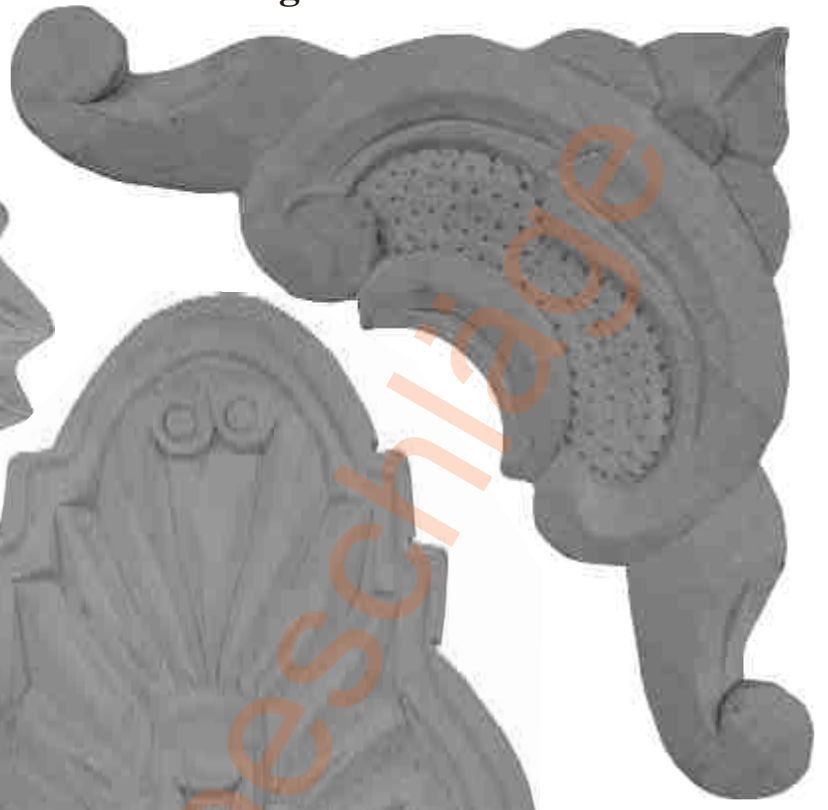

6062



6061



6063

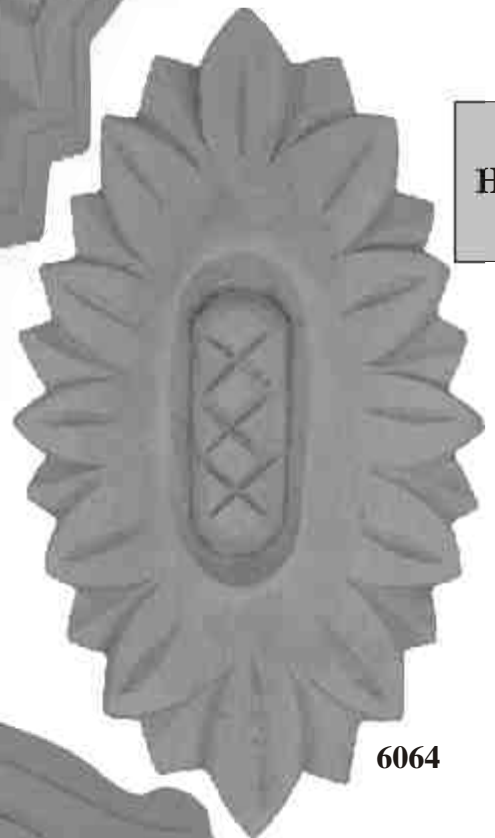

6064



6066

H

# Holzapplikationen, Buche Pressholz

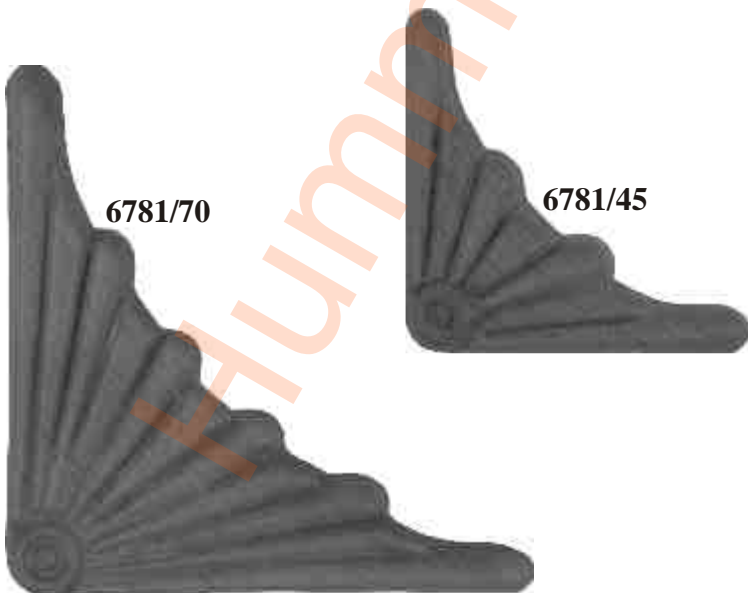

Linde geschnitzt

H

# Holzapplikationen, Buche Pressholz



6786



6787



6027/50

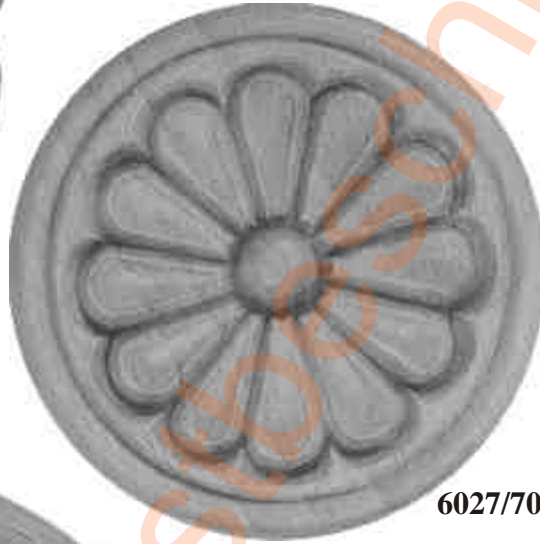

6027/70



6788/90



6788/145

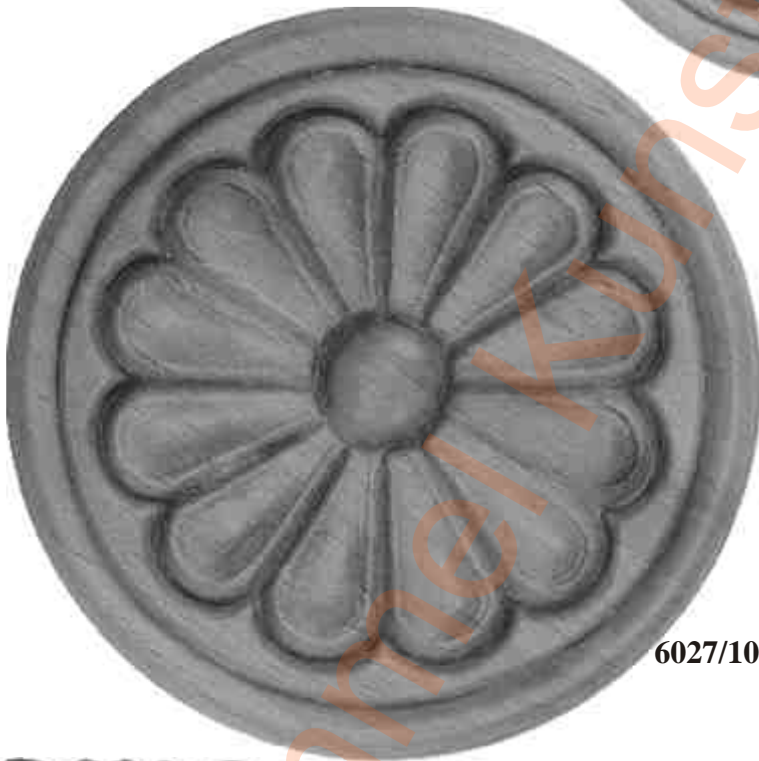

6027/100



6028/23  
6028/28  
6028/34  
6028/44



6029



6032



6031



6030



6080 Fichte geschnitzt 555x53 mm

H

# Holzzierteile, Linde geschnitzt



**6592**  
470x130 mm



**6587**  
192x75 mm



**6586**  
205x55 mm



**6590**  
142x100 mm



**6588**  
230x135 mm



**6589**  
277x152 mm



**6034**  
255x150 mm

H



## Holzzierteile

B = Buche; Kf = Kiefer



**6224/B**  
gedrechselt



**6223/B**  
gedrechselt



**6036**  
Buche  
Pressholz



**6597**  
Linde geschnitzt  
248x115 mm

H

# Holzaufsätze geschnitzt

F = Fichte; Li = Linde



**6532** Linde  
170x460 mm



**6539/F**  
**6539/Li**  
140x350 mm

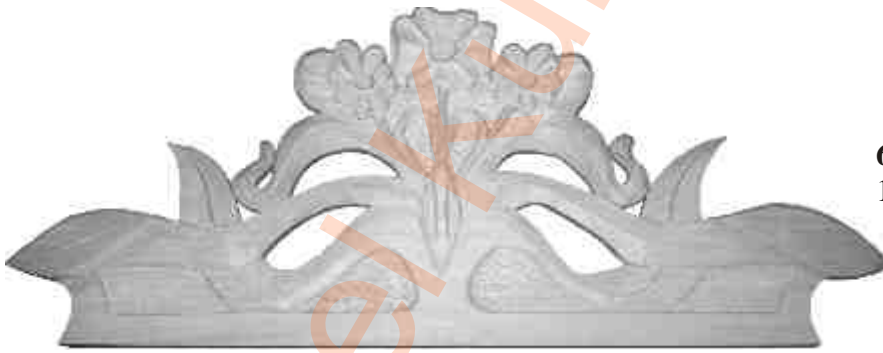

**6527** Linde  
140x370 mm



**6528** Linde  
220x360 mm

H

## Holzaufsätze geschnitzt

F = Fichte; Li = Linde



6531/F 190x635 mm  
6531/Li 200x630 mm  
6537/F 260x800 mm  
6537/Li 260x800 mm



6523/280 Li 90x280 mm  
6523/320 Li 100x320 mm  
6523/460 Li 130x450 mm  
6523/600 F 190x590 mm  
6523/600 Li 195x590 mm



6525 Linde  
135x340 mm



6530/F 160x720 mm  
6530/Li 165x720 mm

H

# Holzaufsätze geschnitzt

Kf = Kiefer; Li = Linde



6526/Kf  
6526/Li  
290x825 mm



6540/Kf  
6540/Li  
250x600 mm



6522/400 Kf 120x400 mm  
6522/400 Li 120x400 mm  
6522/600 Kf 190x600 mm  
6522/600 Li 190x600 mm



6960/Kf  
6960/Li  
300x755 mm

H

# Holzaufsätze geschnitzt

Er = Erle; F = Fichte; Kf = Kiefer; Li = Linde



6521/160 80x167 mm  
6521/250 105x265 mm  
6521/305 135x305 mm  
Linde



6533/Kf  
6533/Li  
200x370 mm



6520/Kf  
6520/Li  
255x860 mm



6535/Er  
6535/Kf  
195x805 mm



6534/F  
6534/Li  
275x1070 mm

H

# Holzteile

Er = Erle; Kf = Kiefer



**6966/200**  
200x37x47 mm  
Linde



**6966/280**  
283x39x70 mm  
Linde

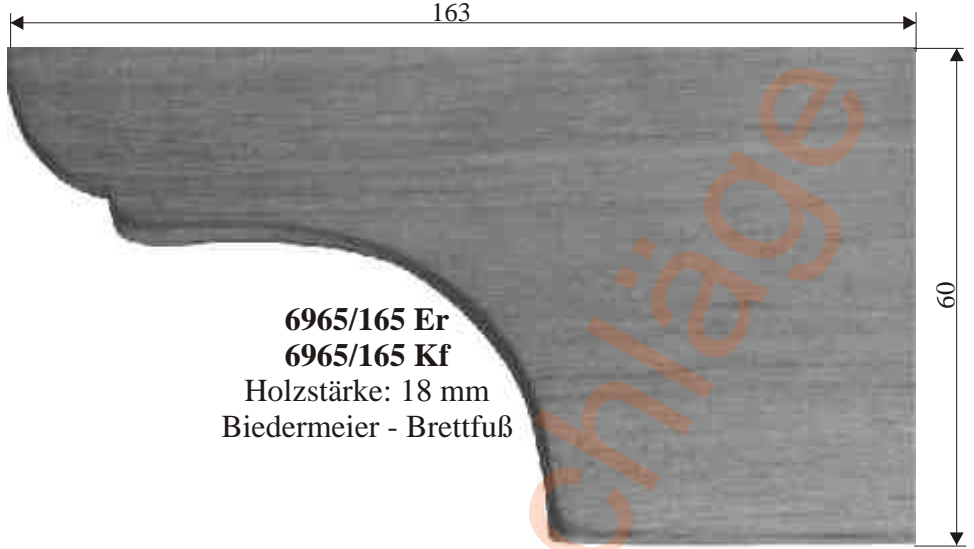

**6965/165 Er**  
**6965/165 Kf**  
Holzstärke: 18 mm  
Biedermeier - Brettfuß

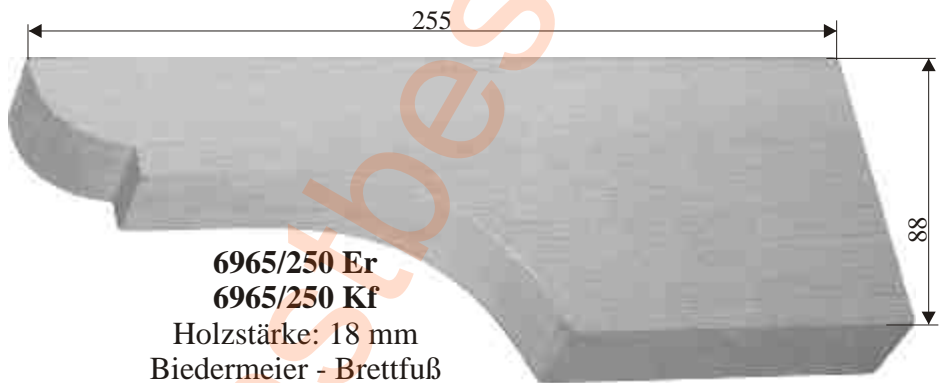

**6965/250 Er**  
**6965/250 Kf**  
Holzstärke: 18 mm  
Biedermeier - Brettfuß

H

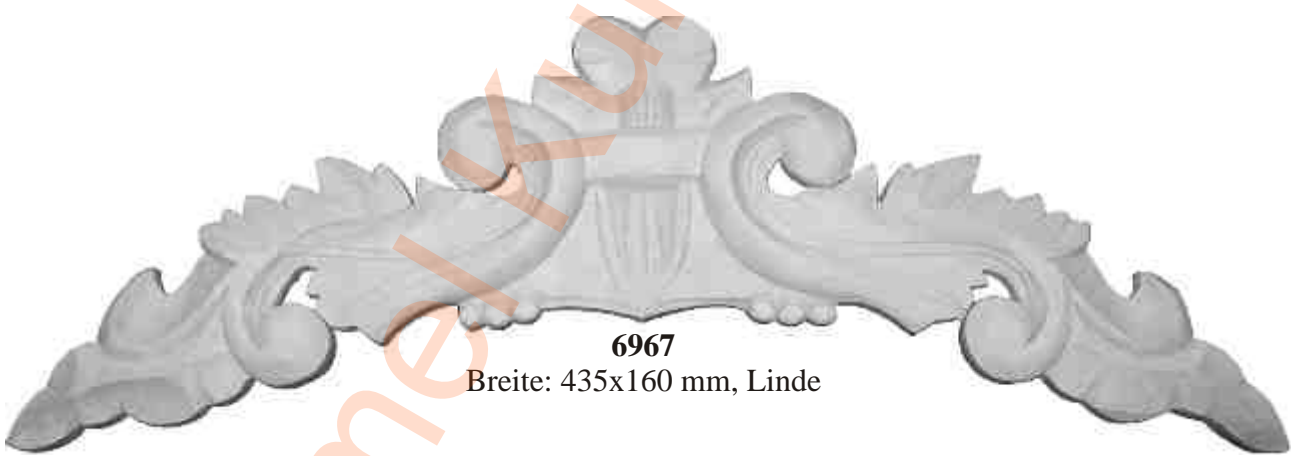

**6967**  
Breite: 435x160 mm, Linde



**6968**  
572x255 mm, Linde



**6969**  
635x235 mm, Linde



**6970**  
575x170 mm, Linde



**6971**  
615x202 mm, Linde

## Tischfüße, Fichte

Länge: 750 mm

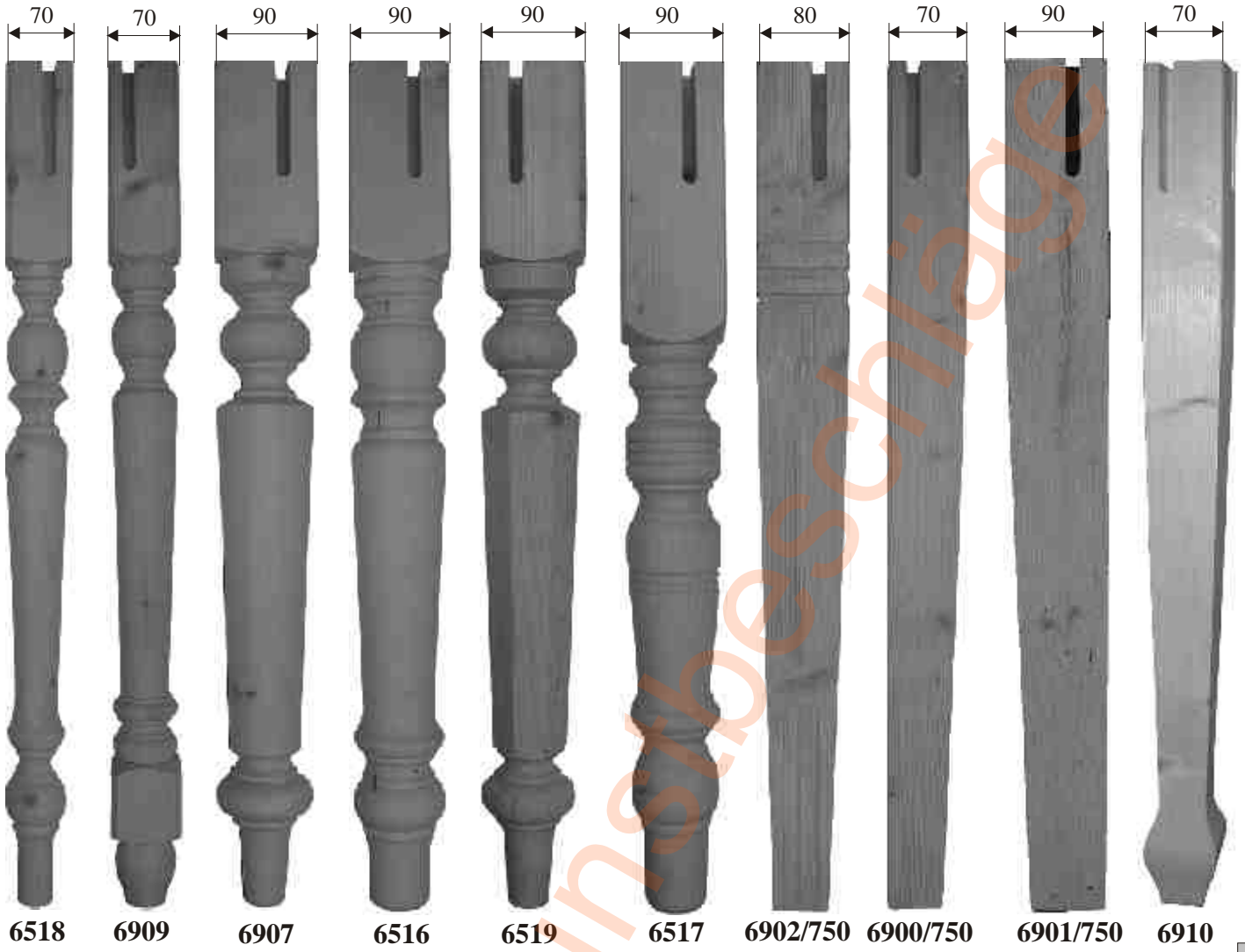

6518

6909

6907

6516

6519

6517

6902/750

6900/750

6901/750

6910

Länge:  
800 mm

## Couchtischfüße, Fichte

Länge: 450 mm

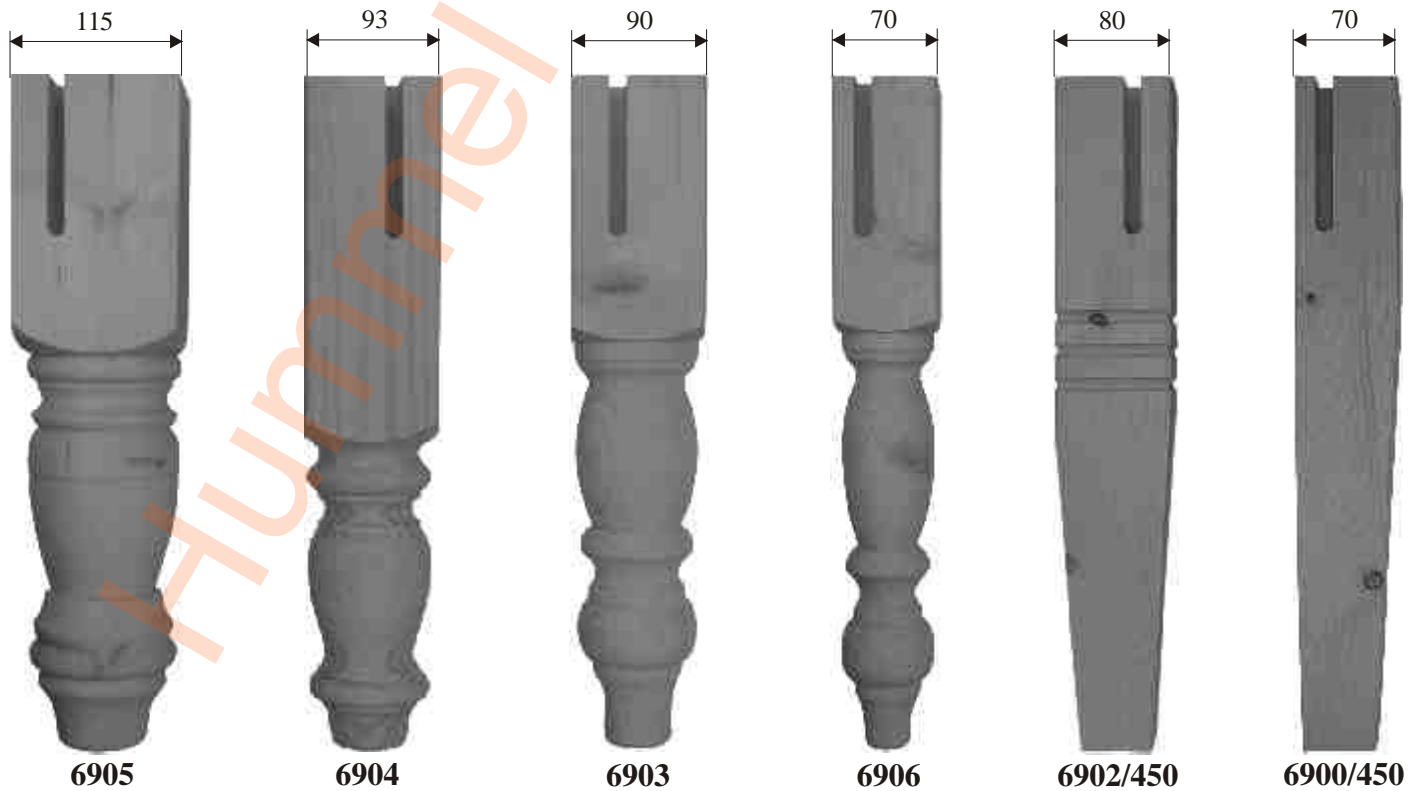

6905

6904

6903

6906

6902/450

6900/450

H

# Holzfüße für Tische und Stühle, Tischverbinder

B = Buche; Er = Erle ; F = Fichte ; Kf = Kiefer



**6505/Er**  
780 mm



**6504/Er**  
780 mm



**6911/F**  
750 mm



**6501/F**  
750 mm



**6500/F**  
750 mm

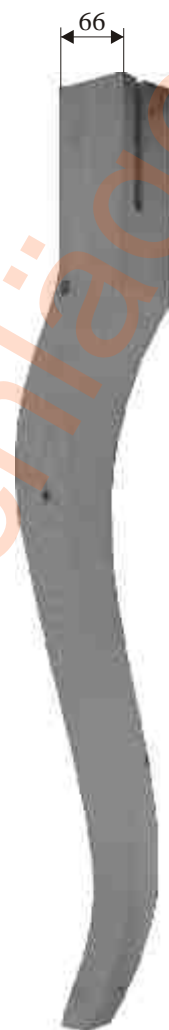

**6507/F**  
750 mm



**6514/700 B**  
765 mm  
**6514/600 B**  
625 mm

H



**6545/Er**  
**6545/Kf**  
Sofafuß



**5626/70**  
Tischfußverbinder  
Eisen verzinkt  
95x70 mm



**5626/S**  
Stockschraube mit Flügelmutter  
für Tischfußverbinder, Eisen verzinkt  
M10x80 mm



## Geschnitzter Aufsatz und Tischunterteile



**6915** Aufsatz-Set (zerlegt)  
L 930 x H 520 x T 330 mm  
Fichte mit Linde-Schnitzereien

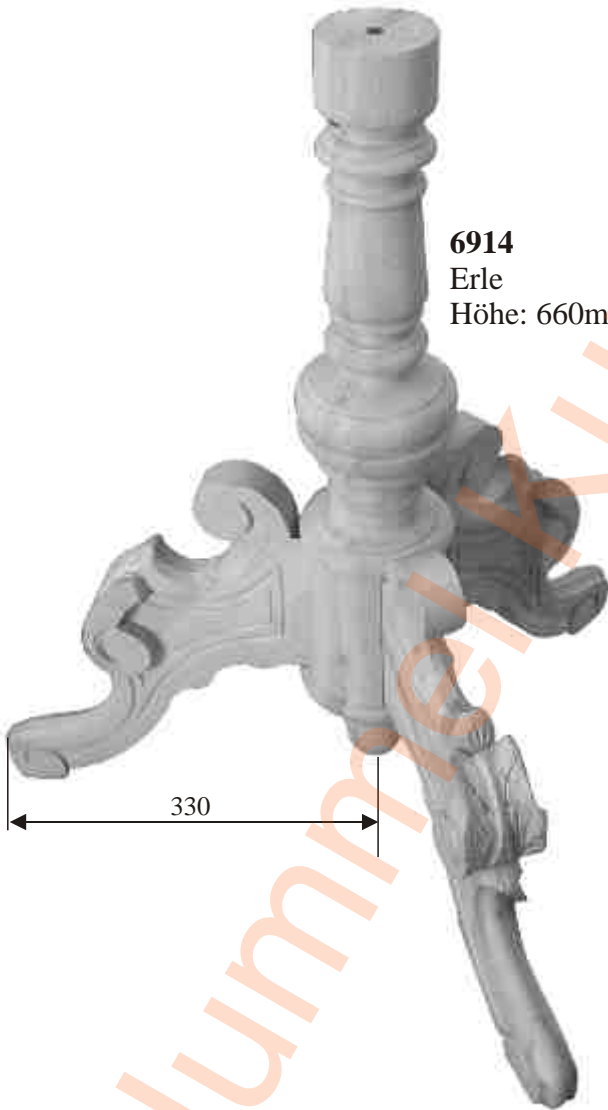

**6914**  
Erle  
Höhe: 660mm



**6506** Erle  
Nähtischuntergestell  
Höhe: 700 mm

H

# Holzleisten, Buche

Länge:

Maß: Nummer:

90 cm

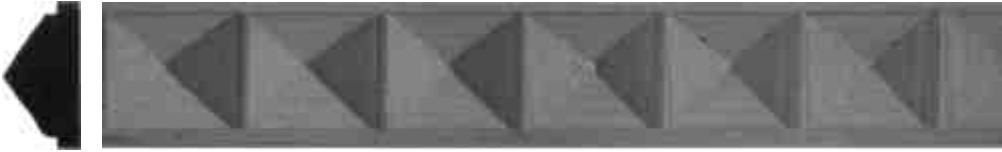

19,5x9 **6763**

2 m



20x6 **6765**

2 m



26x8 **6766**

2 m

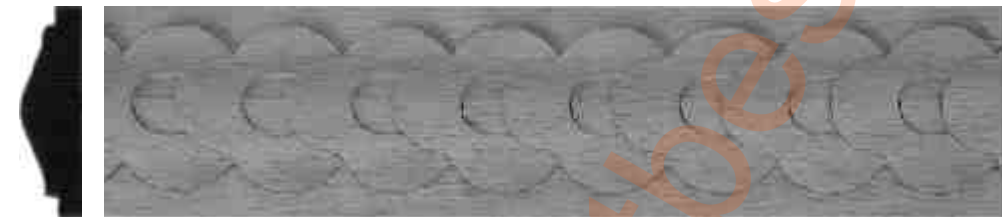

28x8 **6768**

2 m



18x9 **6771**

2 m



15x9 **6771/15**

2 m



33x7 **6769/33**

2 m



24x6 **6769**











2 m



50x30 **6770**

H

# Holzleisten, Buche

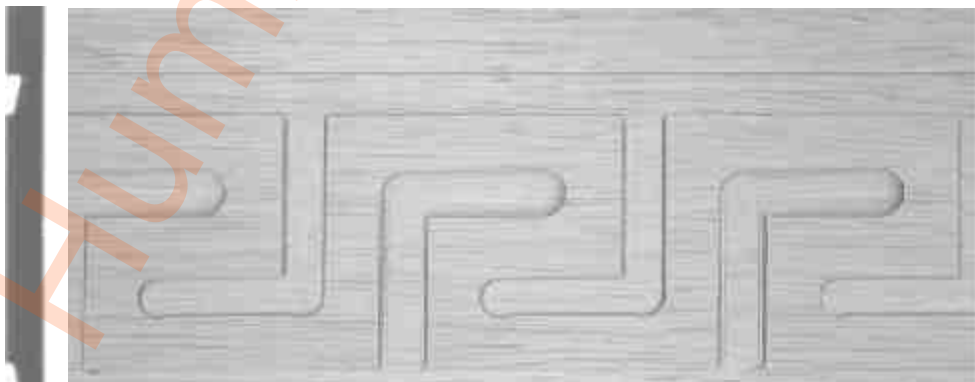
Länge:		Maß:	Nummer:
90 cm		4x4	<b>6724</b>
90 cm		5x5	<b>6725</b>
1 m		5x5	<b>6726</b>
1 m		2,5x5	<b>6727</b>
1 m		3,5x7	<b>6728</b>
1 m		4x8	<b>6729</b>
1 m		6x12	<b>6731</b>
90 cm		4x8	<b>6732</b>
1,8 m		5x10	<b>6733</b>
90 cm		6,5x14,5	<b>6734</b>
2 m		50x5,5	<b>6746/50</b>
2 m		63x5,5	<b>6746/63</b>

H

# Holzleisten, Buche

Länge:

Maß: Nummer:

90 cm



6x13 **6736**

2 m



8x17 **6737**

2 m

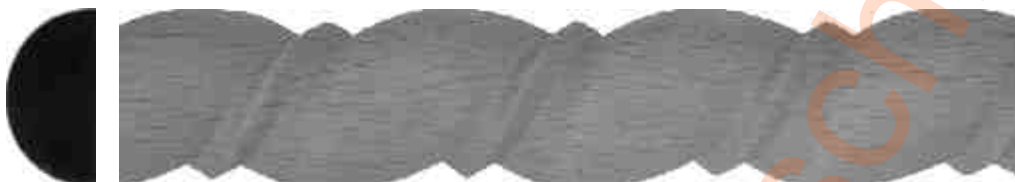

12x24 **6738**

2 m



12x27 **6739**

90 cm



10x4,5 **6740**

H

90 cm



16x6 **6742**

2 m



22x6 **6743**

90 cm

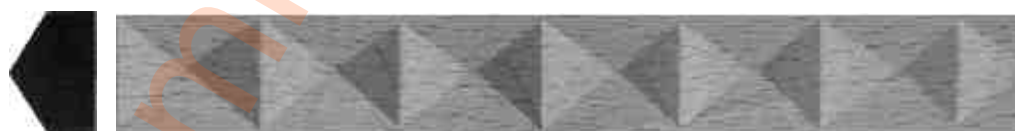

16,5x9 **6749**

2 m

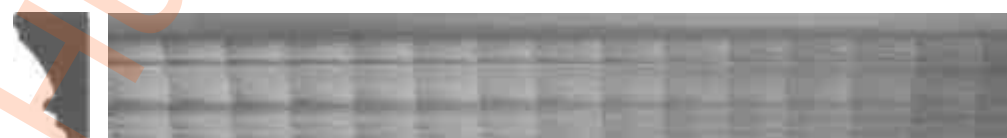

17x9 **6756**

1 m



8,5x4 **6745**

# Holzleisten, Buche

Länge:

Maß: Nummer:

2 m



13,5x8 **6750**

90 cm



15x7 **6751**

90 cm



9,5x5 **6752**

2 m



31x6 **6755**

2 m



13x9 **6754**

2 m



25x12 **6758**

2 m



21x15,5 **6759**

2 m



32x22 **6760**

2 m



38x22 **6761**

H

# Holzprofileleisten, F=Fichte; B=Buche

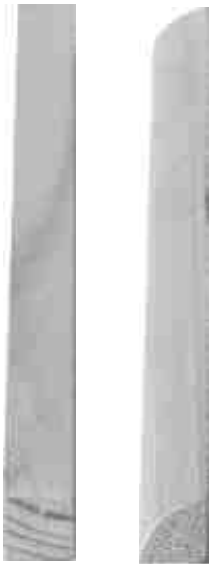

**6259**  
2,4 m

**6714**  
2,4 m



**6255/F** 2,4 m  
**6255/B** 2 m



**6256/F** 2,4 m  
**6256/B** 2 m



**6700**  
2,4 m



**6285/F**  
**6285/B**  
2 m



**6261**  
2,4 m



**6260** 2,4 m



**6706** 2,4 m



**6265**  
2,4 m

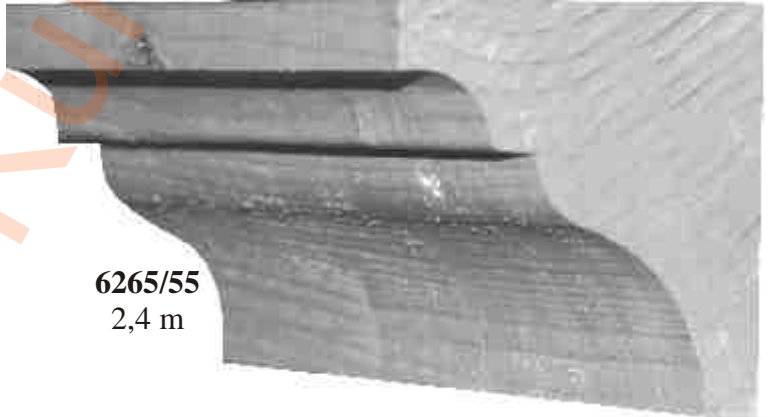

**6265/55**  
2,4 m

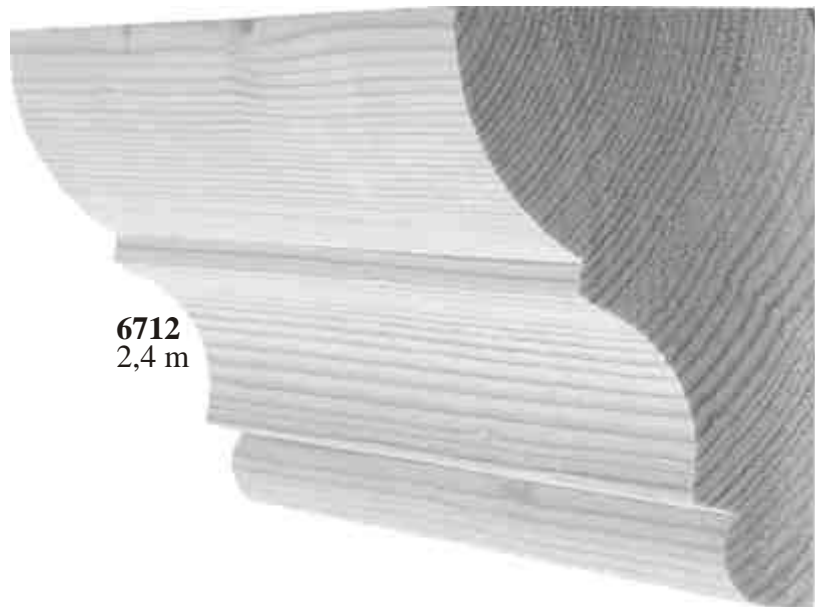

**6712**  
2,4 m



**6258**  
2,4 m



**6262** 2,4 m

H

# Holzprofileisten, Fichte

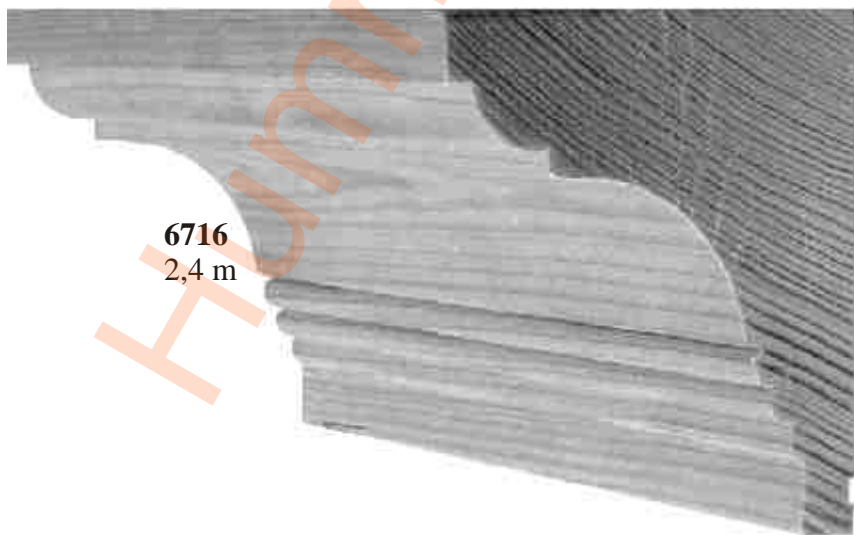
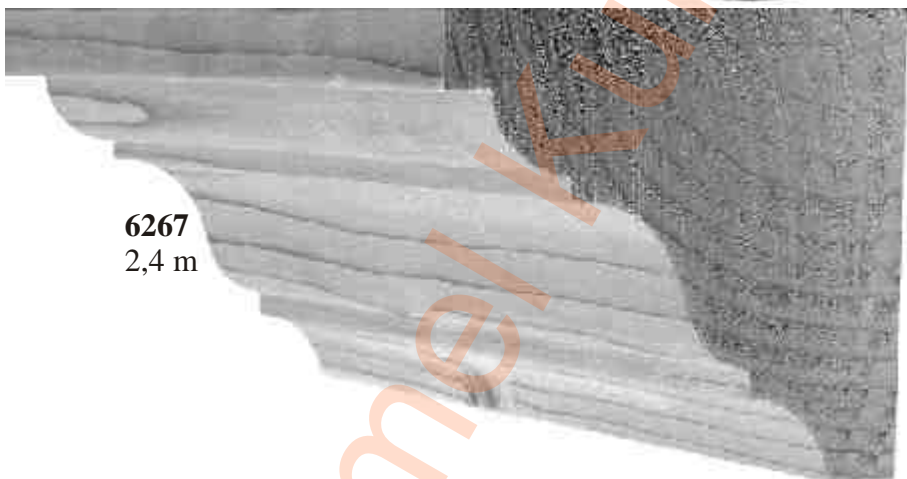
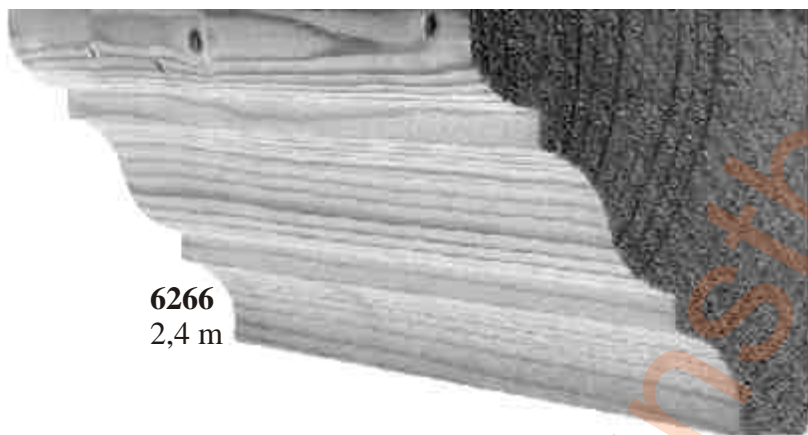

H

## Holzprofileleisten, Fichte



**6257**  
1,8 m



**6701**  
2,4 m



**6702**  
2,4 m



**6704**  
2,4 m



**6268/40** (mm Breite)  
**6268/50**  
**6268/60**  
2,4 m



**Zahnleisten 6280/B** Buche, 2 m Länge, Querschnitt: 18x18 mm, Zahnabstand 35 mm



**Zahnleisten 6280/F** Fichte, 2,1 m Länge, Querschnitt: 27x18 mm, Zahnabstand: 66 mm  
**6280/M** Meranti, 2,1 m Länge, Querschnitt: 27x18 mm, Zahnabstand 71 mm

### Kannelierte Leisten



**6281/40 mm**  
**/50**  
**/60**  
**/70**  
**/80**  
2,4 m Länge  
Fichte



**6282/35 mm**  
**/45**  
**/60**  
1,8 m Länge  
Fichte



**6284/35 mm**  
**/45**  
1,8 m Länge  
Fichte



# Holzansätze und Bogenleisten

**6719** Linde  
1520 mm  
mit Seitenleiste

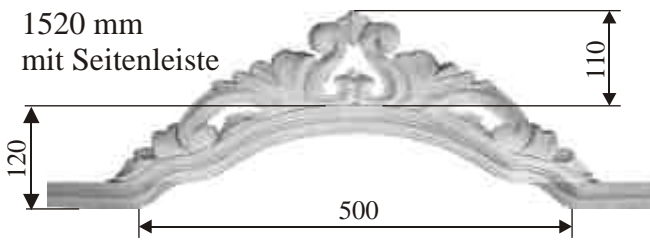

**6720** Linde  
1520 mm  
mit Seitenleiste

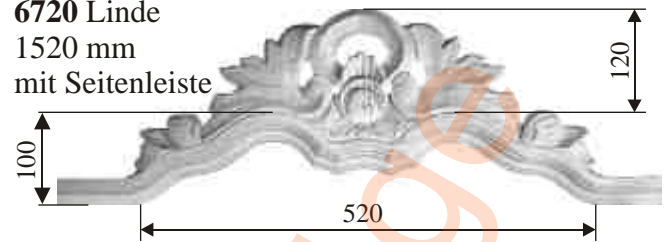

**6721** Linde  
1520 mm  
mit Seitenleiste

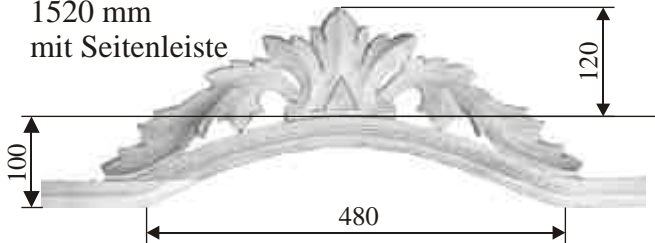

**6723** Linde  
1520 mm  
mit Seitenleiste

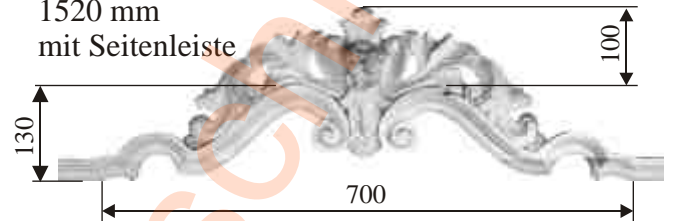

**6792** Buche Pressholz 750x70x11 mm



**6793** Linde Pressholz 1075x100x20 mm

**6271/29x32 F** Fichte  
**6271/29x32 B** Buche

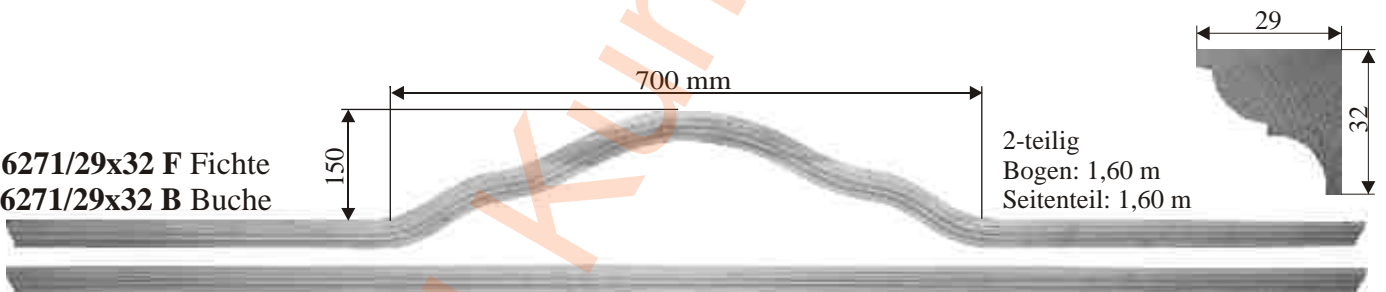

**6271/42x40 F** Fichte  
**6271/42x40 B** Buche

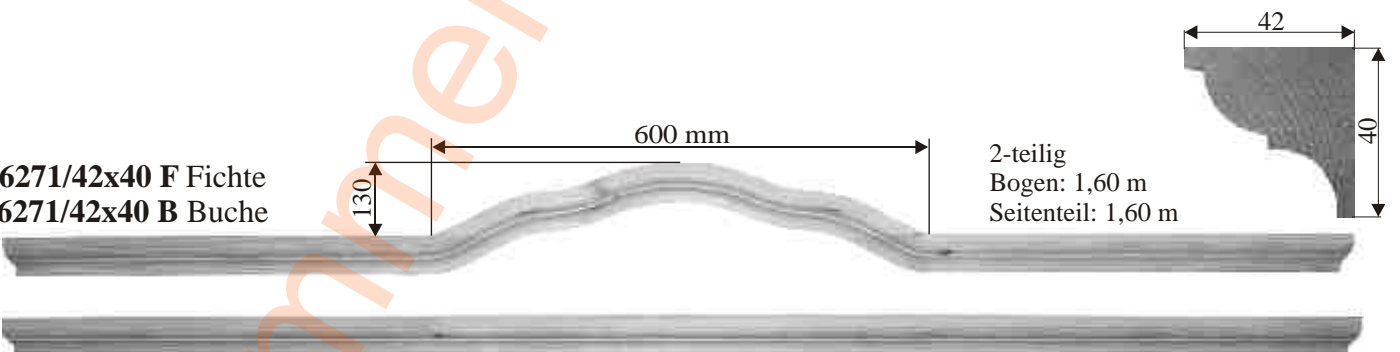

**6272/42x40 F** Fichte  
**6272/42x40 B** Buche

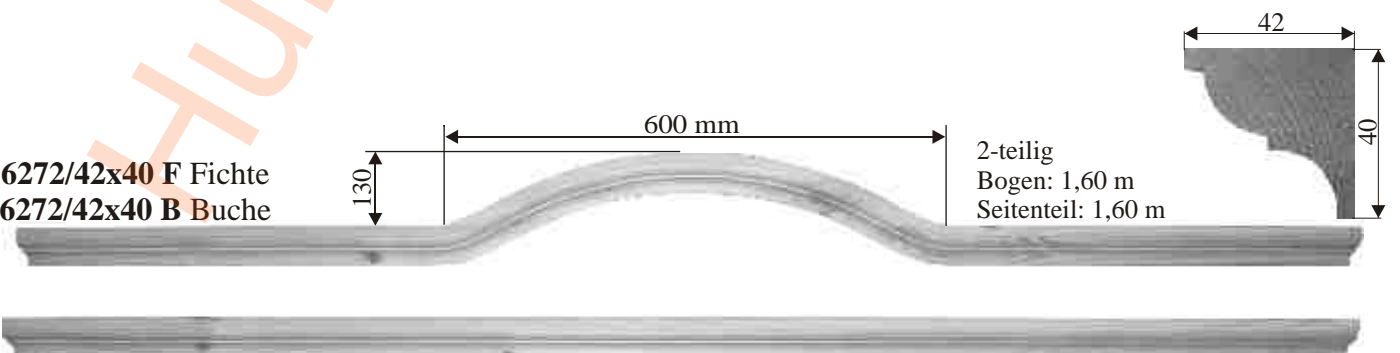

H

# Intarsiensterne

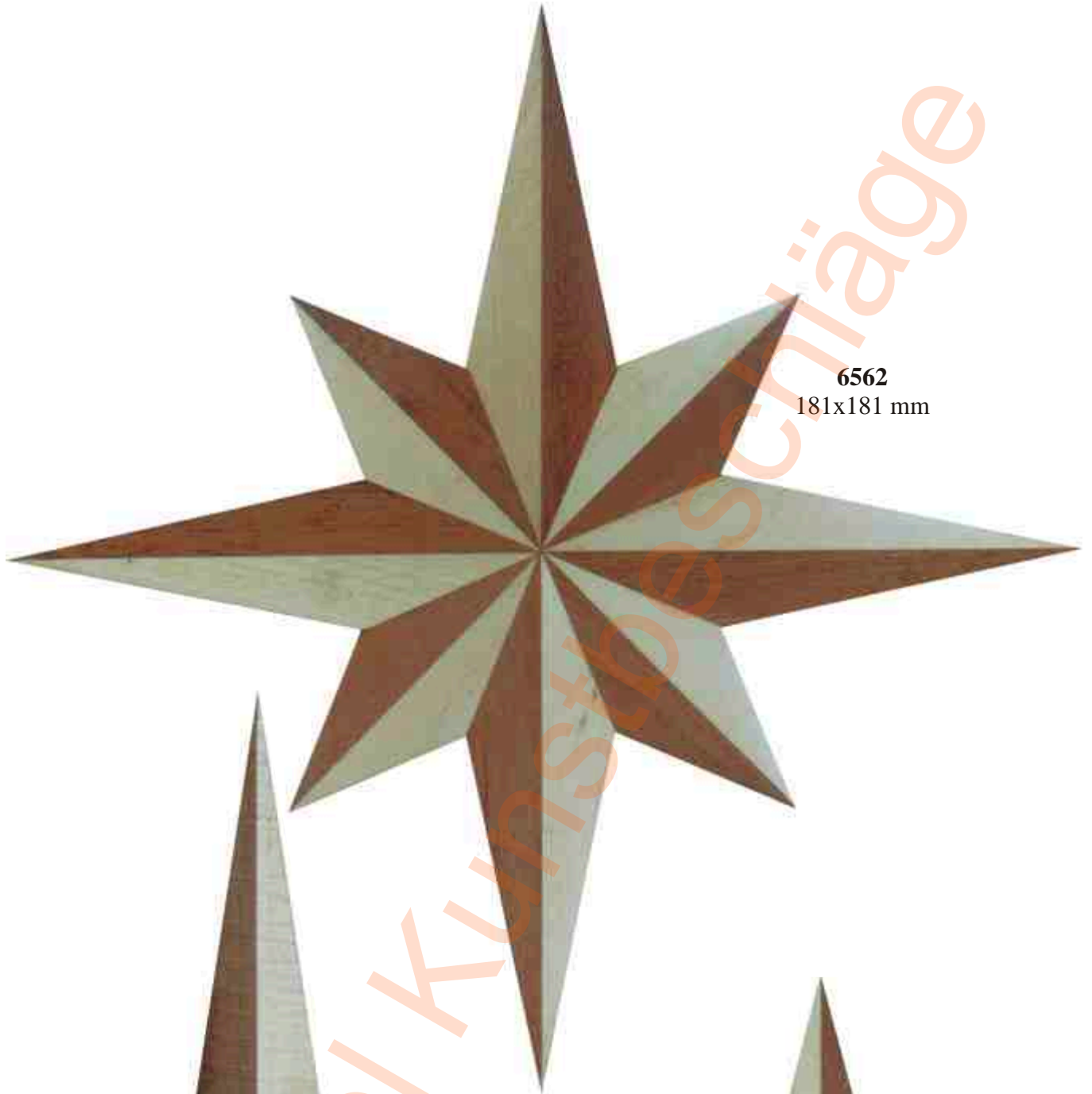

**6562**  
181x181 mm

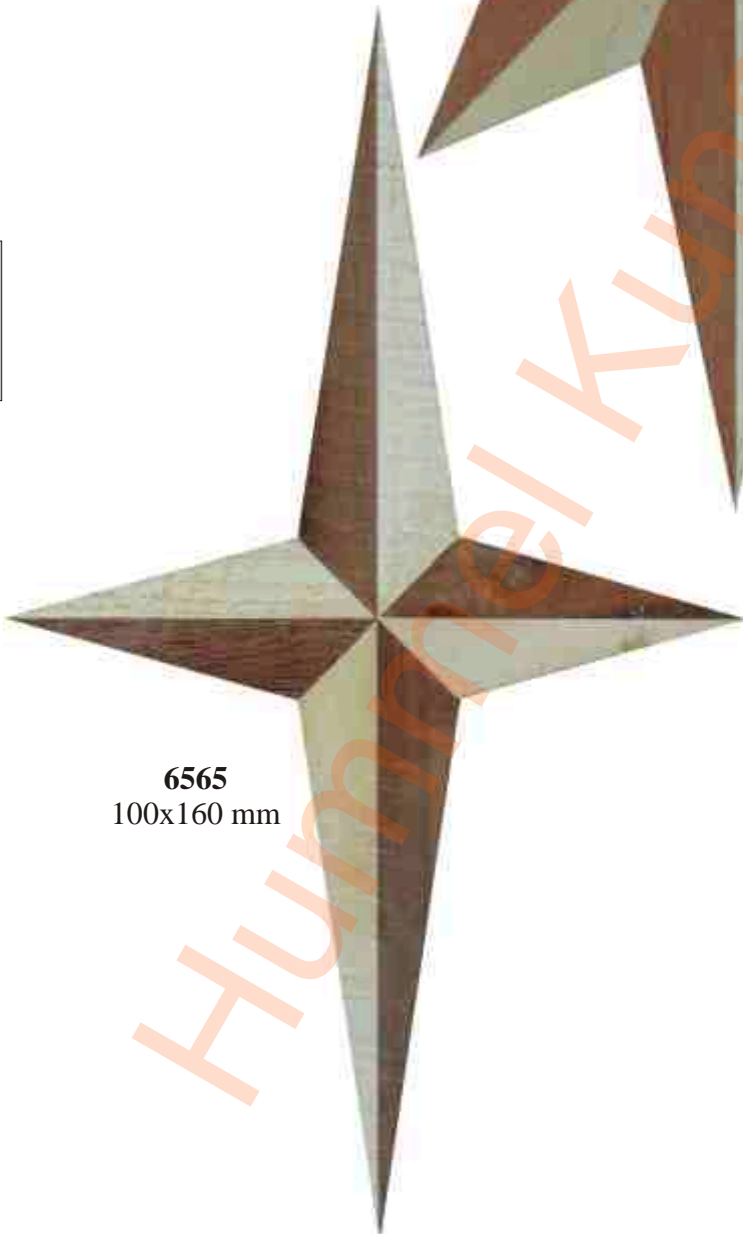

**6565**  
100x160 mm

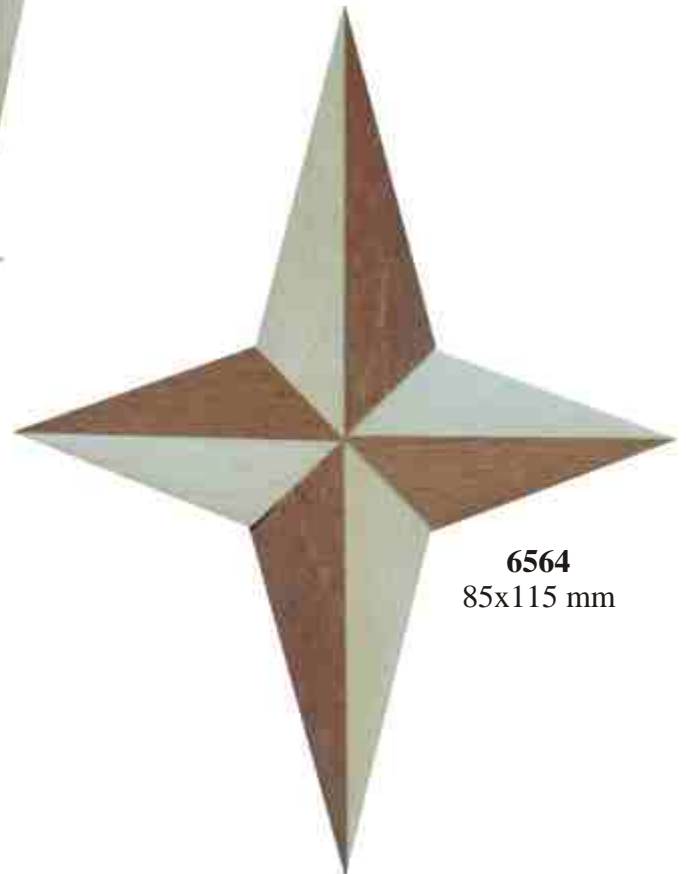

**6564**  
85x115 mm

H

# Intarsiensterne

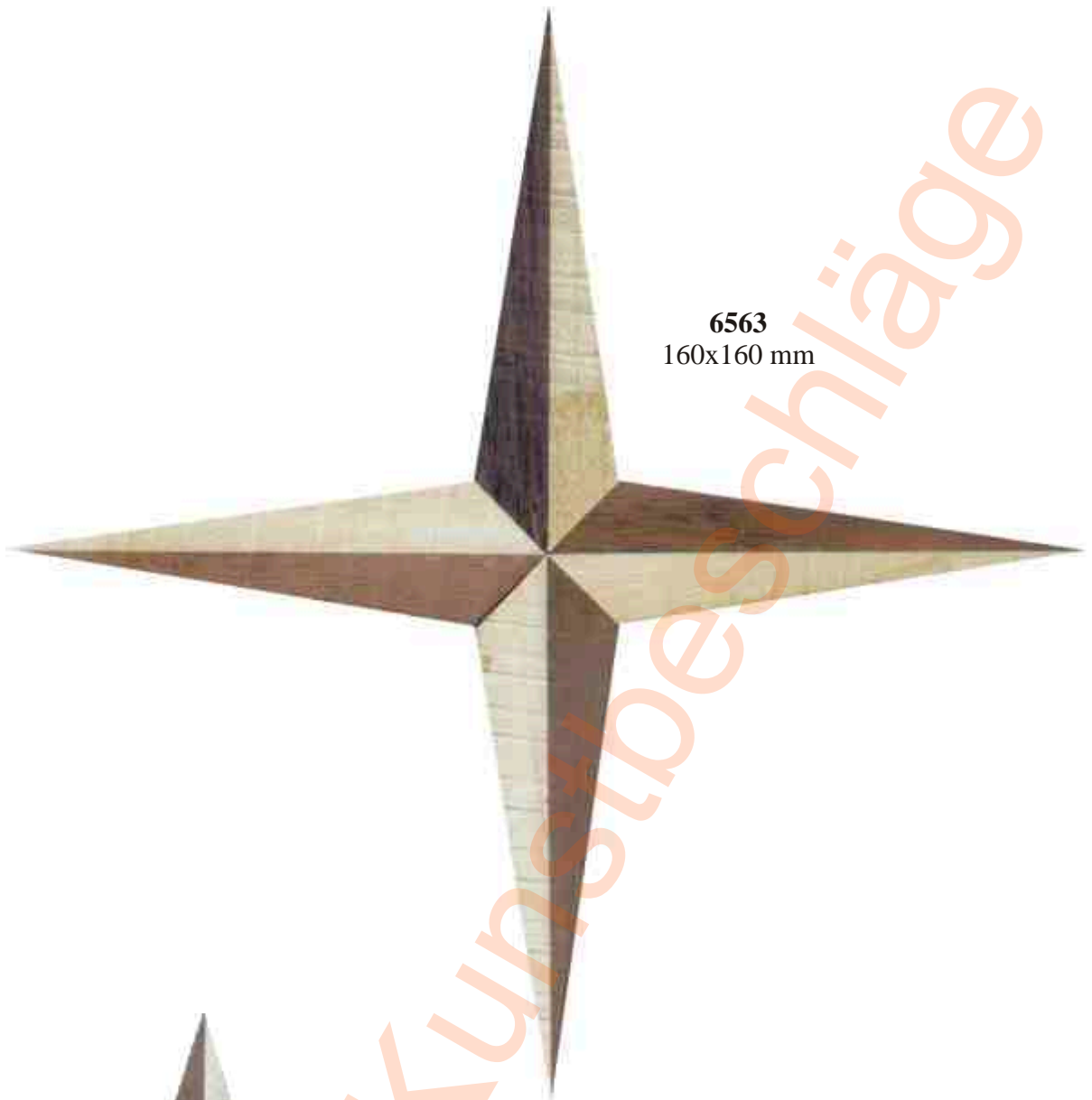

**6563**  
160x160 mm

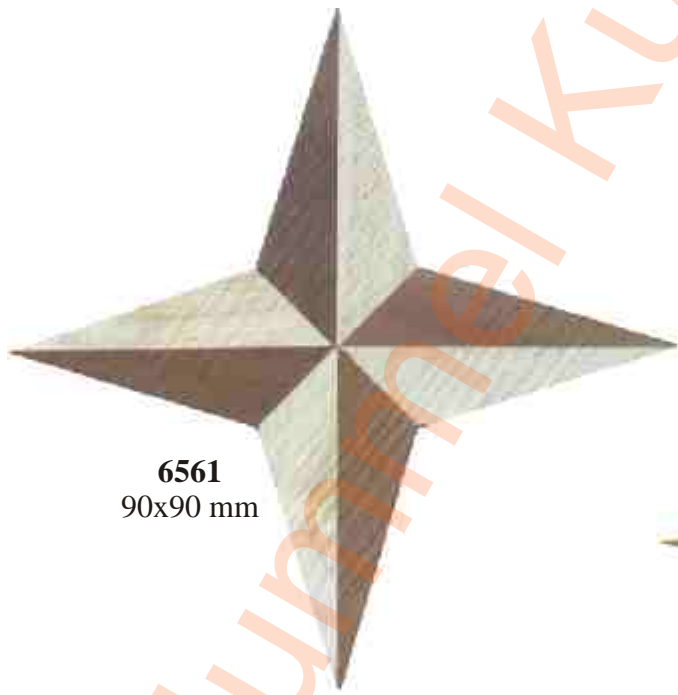

**6561**  
90x90 mm

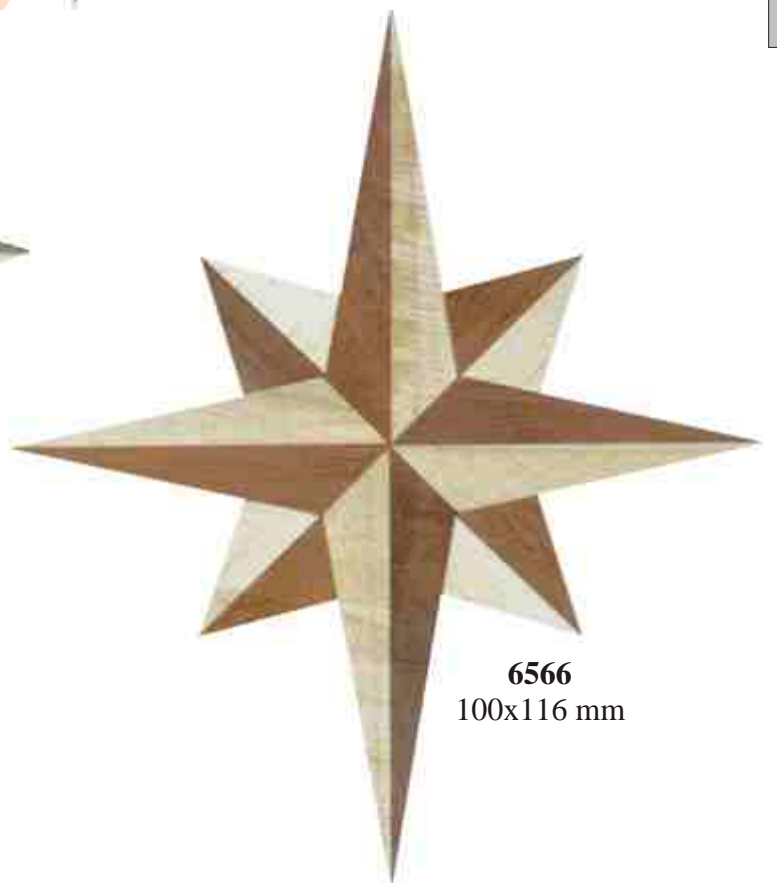

**6566**  
100x116 mm

**Bandintarsien Länge 1 m, 2 mm stark**

6922



6923



6924



6925



6926



6927



6928



6930



6931



6932



6933



6934



6935



6936



6937



6938



6939



6551



6558



6552



H

# Stuhlsitzplatten, Stuhlgeflechte

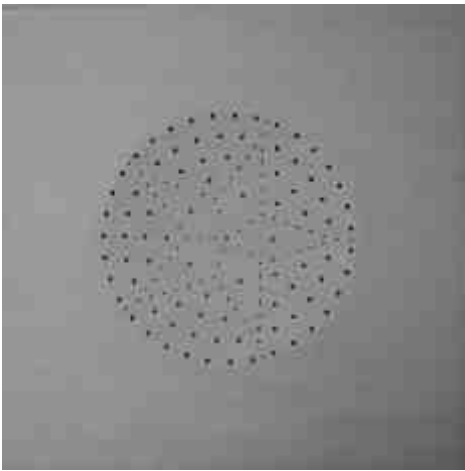

**6297**

Stuhlsitzplatte gebohrt und **gewölbt** !  
Sperrholz Buche furniert  
500x500 mm

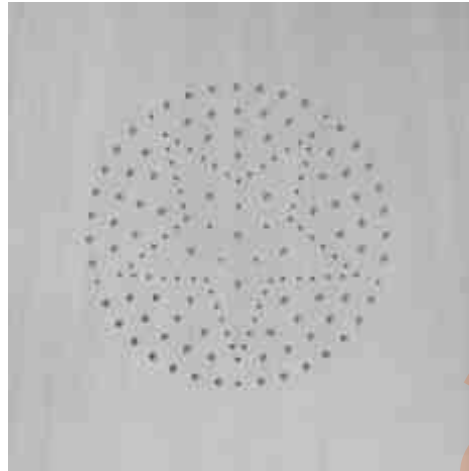

**6299**

Stuhlsitzplatte gebohrt  
Sperrholz Buche furniert  
400x400 mm



**6298-1**

Stuhlsitzplatte gemustert  
eingepägt  
Sperrholz Buche furniert  
450x450 mm



Stuhlgeflecht zur Stuhlreparatur oder Neuerstellung

Pro angefangenen 10 cm Länge:

**6953/40** (40 cm breit)

**6953/50** (50 cm breit)

**6953/60** (60 cm breit)

Ganze Rolle

(15,2 Meter):

**6954/40** (40 cm breit)

**6954/50** (50 cm breit)

**6954/60** (60 cm breit)

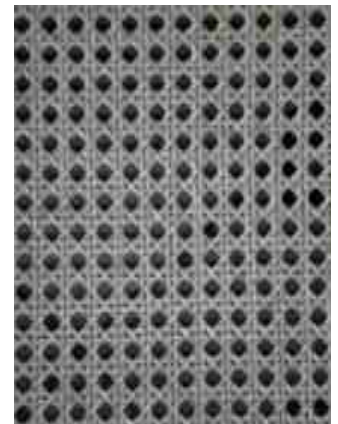

Wir schneiden Ihnen jede gewünschte Länge ab!

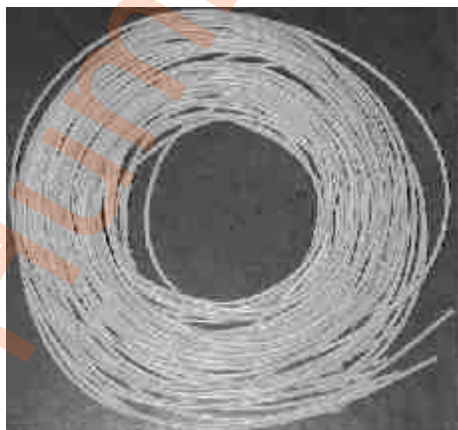

Spezielles Rundholzprofil  
um das Geflecht einzuspannen.  
Ø 5,2 mm

Pro angefangenen 10 cm Länge:

**6954/S**

Wir schneiden Ihnen jede gewünschte Länge ab!

# Kleiderstangenhalter und Kleiderstangen



**6077/90**  
Birke  
2 cm dick

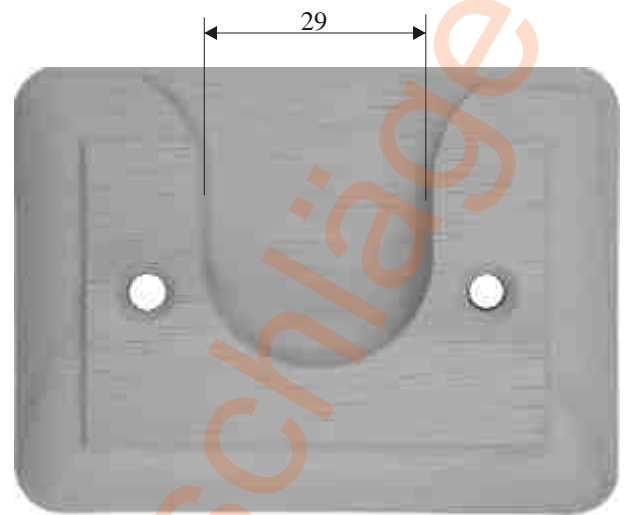

**6077**  
Linde



**6717**  
Kleiderstange aus Esche  
Ø-28mm, 1600mm

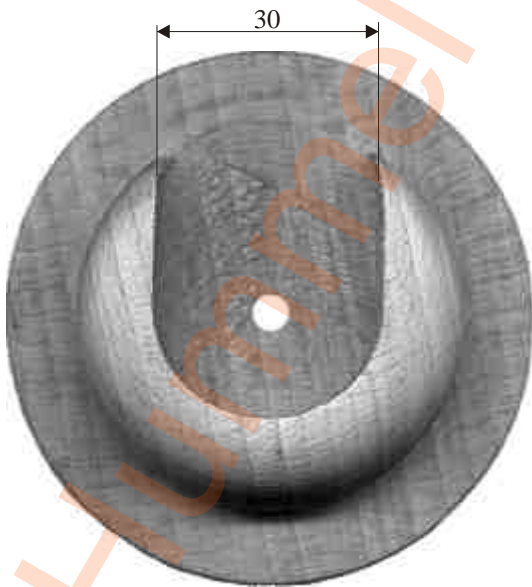

**6596**  
Buche

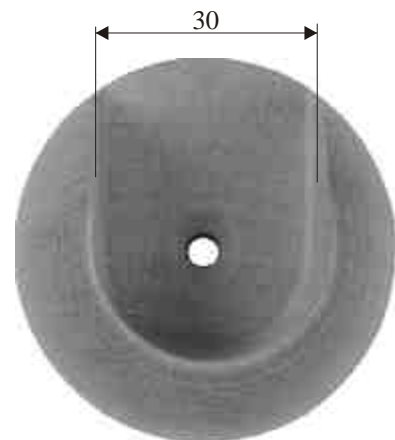

**6076**  
Buche

## Verschiedene Holzteile



**6794/B** Buche  
**6794/E** Eiche  
**6794/F** Fichte  
**6794/Kf** Kiefer  
**6794/L** Lärche  
 Querholzblättchen-Sortiment 1kg Karton  
 Ø: 15, 20, 25, 30, 35 mm  
 zum Einschlagen in ausgebohrte Astlöcher

Riffeldübel  
 Packung zu 100 Stück:  
**6798/6** mm Ø

/8  
 /10  
 /12  
 /14  
 /16  
 /20



Riffelstäbe 1 Meter  
**6952/6** Ø 6 mm  
**6952/8** Ø 8 mm  
**6952/10** Ø 10 mm  
**6952/12** Ø 12 mm  
**6952/15** Ø 15 mm  
**6952/18** Ø 18 mm

Einzelne Dübel:  
**6797/6**  
 /8  
 /10  
 /12  
 /14  
 /16  
 /20

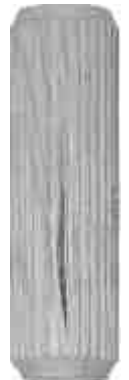

H



**6948/150** Fichte (150 mm lang)  
**6948/200** Fichte (200 mm lang)  
**6949/150** Eiche  
**6949/200** Eiche  
 Holznagel 8-eckig Ø 20 mm



**6950/150** Fichte (150 mm lang)  
**6950/200** Fichte (200 mm lang)  
**6951/150** Eiche  
**6951/200** Eiche  
 Holznagel 6-eckig mit  
 Vierkantkopf 20x20 mm



**6946/150** Fichte (150 mm lang)  
**6946/200** Fichte (200 mm lang)  
**6947/150** Eiche  
**6947/200** Eiche  
 Holznagel rund Ø 20 mm

# Verschiedene Holzteile

Bi = Birke; B = Buche; E = Eiche; F = Fichte

## Holzziernägel

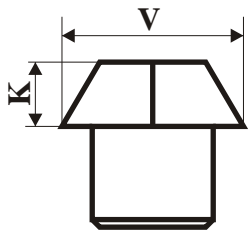

	Vierkant V in mm	Kopfhöhe K in mm
<b>6093/16 B</b>	16x16	12
<b>6093/16 F</b>	16x16	12
<b>6093/20 B</b>	20x20	15
<b>6093/20 F</b>	20x20	15

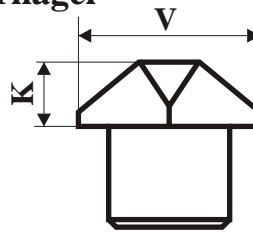

	Vierkant V in mm	Kopfhöhe K in mm
<b>6094/16 B</b>	16x16	10
<b>6094/16 F</b>	16x16	10
<b>6094/20 B</b>	20x20	11
<b>6094/20 F</b>	20x20	11

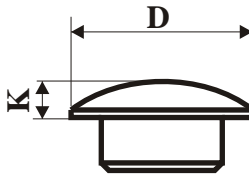

	Durchm. D in mm	Kopfhöhe K in mm
<b>6096/22 B</b>	22	7
<b>6096/22 F</b>	22	7

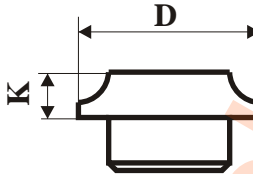

	Durchm. D in mm	Kopfhöhe K in mm
<b>6095/22 B</b>	22	8
<b>6095/22 F</b>	22	8
<b>6095/27 B</b>	27	8
<b>6095/27 F</b>	27	8



Abdeckkappen für Muttern  
**6940/45** D1:35 D2:45 mm  
**6940/55** D1:45 D2:55 mm  
 Fichte

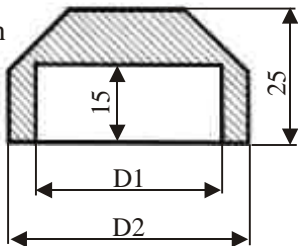

Abdeckhut für Muttern  
**6941/56** D1:25 D2:40 D3:56 mm  
**6941/64** D1:30 D2:47 D3:64 mm  
 Fichte

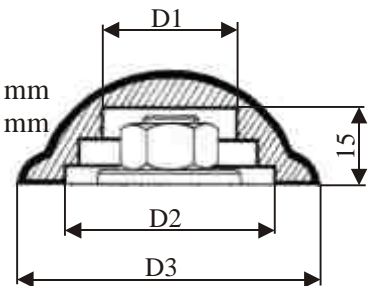

H



Vierkantholzknägel (konisch)  
 Packung zu je 50 Stück:  
**6791/6 Bi** 6x6x40 mm  
**6791/6 F** 6x6x40 mm  
**6791/8 Bi** 8x8x60 mm  
**6791/8 F** 8x8x60 mm  
**6791/10 Bi** 10x10x80 mm  
**6791/10 F** 10x10x80 mm

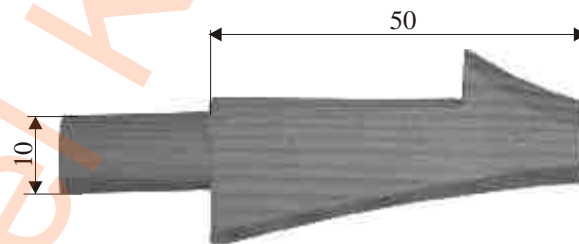

Aufhänger  
**6799/50 E**  
**6799/50 F**

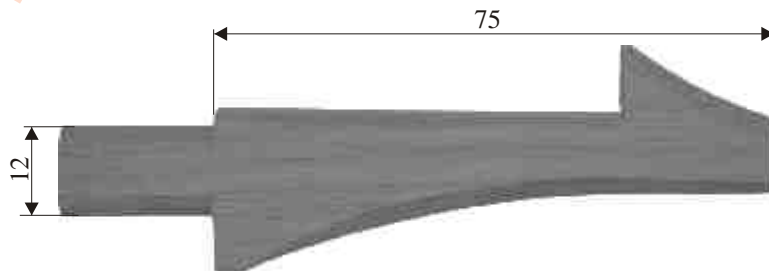

Aufhänger  
**6799/75 E**  
**6799/75 F**

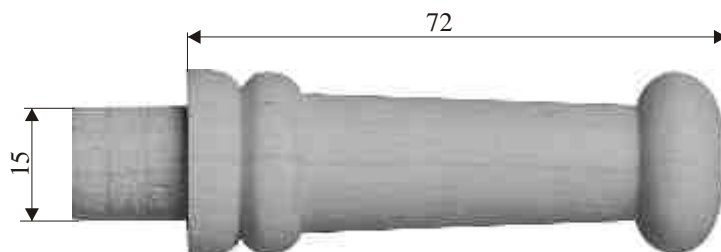

Aufhänger  
**6085/B**